



Ref. Certif. No.

JPTUV-086753

IEC SYSTEM FOR MUTUAL RECOGNITION OF TEST  
CERTIFICATES FOR ELECTRICAL EQUIPMENT  
(IECEE) CB SCHEME

SYSTEME CEI D'ACCEPTATION MUTUELLE DE  
CERTIFICATS D ESSAIS DES EQUIPEMENTS  
ELECTRIQUES (IECEE) METHODE OC

### CB TEST CERTIFICATE

### CERTIFICAT D'ESSAI OC

Product  
Produit

DC-DC Converter

Name and address of the applicant  
Nom et adresse du demandeur

Mornsun Guangzhou Science & Technology Co., Ltd.  
NO.5,Kehui St.1, Kehui  
Development Center, Science Ave., Guangzhou Science City, Luogang  
District, Guangzhou 510663, P. R. China

Name and address of the manufacturer  
Nom et adresse du fabricant

Mornsun Guangzhou Science & Technology Co., Ltd.  
NO.5,Kehui St.1, Kehui  
Development Center, Science Ave., Guangzhou Science City, Luogang  
District, Guangzhou 510663, P. R. China

Name and address of the factory  
Nom et adresse de l'usine

Mornsun Guangzhou Science & Technology Co., Ltd.  
No.8 Nanyun Road 4,  
Guangzhou Science Park, Guangzhou 510663, P. R. China

Ratings and principal characteristics  
Valeurs nominales et caractéristiques principales

Input : DC 4.5-5.5V; 0.33A; Class III  
Output: DC 5.0V; 0.2A

Trademark (if any)  
Marque de fabrique (si elle existe)

MORNSUN

Type of Manufacturer's Testing Laboratories used  
Type de programme du laboratoire d'essais constructeur

N/A

Model / Type Ref.  
Ref. de type

H0505S-1WR2-YG

Additional information (if necessary may also be  
reported on page 2)  
Les informations complémentaires (si nécessaire,  
peuvent être indiqués sur la 2<sup>ème</sup> page)

A sample of the product was tested and found  
to be in conformity with  
Un échantillon de ce produit a été essayé et a été  
considéré conforme à la

IEC 62368-1:2014  
See Test Report for National Differences

As shown in the Test Report Ref. No. which forms part  
of this Certificate  
Comme indiqué dans le Rapport d'essais numéro de  
référence qui constitue partie de ce Certificat

50125105 001

This CB Test Certificate is issued by the National Certification Body  
Ce Certificat d'essai OC est établi par l'Organisme National de Certification



TÜV Rheinland Japan Ltd.  
Global Technology Assessment Center  
4-25-2 Kita-Yamata, Tsuzuki-ku  
Yokohama 224-0021 Japan  
Phone + 81 45 914-3888  
Fax + 81 45 914-3354  
Mail: info@jpn.tuv.com  
Web: www.tuv.com

James Chen

Date: 29.03.2018

Signature:



Test Report issued under the responsibility of:



**TEST REPORT  
IEC 62368-1**

**Audio/video, information and communication technology equipment  
Part 1: Safety requirements**

**Report Number** .....: 50125105 001  
**Date of issue** .....: Mar. 26, 2018  
**Total number of pages** .....: 49

**Applicant's name** .....: **Mornsun Guangzhou Science &Technology Co., Ltd.**  
**Address** .....: NO.5, Kehui St.1, Kehui Development Center, Science Ave., Guangzhou Science City, Luogang District, Guangzhou 510663, P.R. China

**Test specification:**  
**Standard** .....: IEC 62368-1:2014 (Second Edition)  
**Test procedure** .....: CB Scheme  
**Non-standard test method**.....: N/A

**Test Report Form No.**.....: IEC62368\_1B  
**Test Report Form(s) Originator** .....: UL (US)  
**Master TRF** .....: 2014-03

**Copyright © 2014 Worldwide System for Conformity Testing and Certification of Electrotechnical Equipment and Components (IECEE), Geneva, Switzerland. All rights reserved.**  
 This publication may be reproduced in whole or in part for non-commercial purposes as long as the IECEE is acknowledged as copyright owner and source of the material. IECEE takes no responsibility for and will not assume liability for damages resulting from the reader's interpretation of the reproduced material due to its placement and context.  
 If this Test Report Form is used by non-IECEE members, the IECEE/IEC logo and the reference to the CB Scheme procedure shall be removed.

**This report is not valid as a CB Test Report unless signed by an approved CB Testing Laboratory and appended to a CB Test Certificate issued by an NCB in accordance with IECEE 02.**

**General disclaimer:**  
 The test results presented in this report relate only to the object tested.  
 This report shall not be reproduced, except in full, without the written approval of the Issuing CB Testing Laboratory. The authenticity of this Test Report and its contents can be verified by contacting the NCB, responsible for this Test Report.

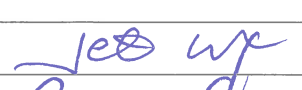
Test item description.....:		DC-DC Converter	
Trade Mark .....		<b>MORNSUN</b>	
Manufacturer.....:		Same as applicant	
Model/Type reference.....:		H0505S-1WR2-YG	
Ratings.....:		Input: 4.5-5.5Vdc, 0.33A Output: 5.0Vdc, 0.2A	
Testing procedure and testing location:			
<input checked="" type="checkbox"/>	CB Testing Laboratory:	TÜV Rheinland (Shenzhen) Co., Ltd.	
Testing location/ address.....:		East of F/1, F/2~F/4, Building 1, Cybio Technology Building No. 6 Langshan No.2 Road, North Hi-tech Industry Park 518057 Shenzhen Nanshan District CHINA	
<input type="checkbox"/>	Associated CB Testing Laboratory:	N/A	
Testing location/ address.....:		N/A	
Tested by (name + signature).....:		Jet Luo	
Approved by (name + signature) .....		Sommy Chen	
<input type="checkbox"/>	Testing procedure: TMP/CTF Stage 1:		
Testing location/ address.....:			
Tested by (name + signature).....:			
Approved by (name + signature) .....			
<input type="checkbox"/>	Testing procedure: WMT/CTF Stage 2:		
Testing location/ address.....:			
Tested by (name + signature).....:			
Witnessed by (name + signature).....:			
Approved by (name + signature) .....			
<input type="checkbox"/>	Testing procedure: SMT/CTF Stage 3 or 4:		
Testing location/ address.....:			
Tested by (name + signature).....:			
Witnessed by (name + signature).....:			
Approved by (name + signature) .....			
Supervised by (name + signature).....:			

**List of Attachments (including a total number of pages in each attachment):**

Attachment 1: National Differences (16 pages)

Attachment 2: Photo documentation (5 pages)

**Summary of testing:**
**Tests performed (name of test and test clause):**

All applicable tests as described in Test Case and Measurement Sections were performed.

- The specified maximum ambient temperature is 71°C (full load with output current) and 85°C (10% load with output current). Test samples without serial numbers.
- Load conditions used during testing see appended table B.2.5 for details.

5.2	Electrical energy source classifications
5.4.1.5.2*	Test for pollution degree 1 environment
5.4.8*	Humidity test
5.4.9*	Electric strength test
6.3.2, B.2.6	Maximum operating temperatures for materials, components and systems
6.2.2	Electrical power sources (PS) measurements for classification
B.2.5	Input tests
B.4	Simulated single fault conditions
F.3.9	Durability, legibility and permanence of markings
Q.1.2*	Limited power sources
Table F.5 of IEC 60664-1*	Impulse test

**Testing location:**

Unless otherwise indicated, all tests were performed at the location stated in "Testing procedure and testing location".

\*. Above test were conducted as client request.

**Summary of compliance with National Differences:**

EU Group Differences, EU Special National Conditions, AT, BE, CH, CZ, DE, FI, FR, GB, GR, HU, IT, NL, NO, PL, SE, SI, SK, US, CA

Explanation of used codes: AT=Austria, BE=Belgium, CH=Switzerland, CZ=Czech Republic, DE=Germany, FI=Finland, FR=France, GB=United Kingdom, GR=Greece, HU=Hungary, IT=Italy, NL=The Netherlands, NO=Norway, PL=Poland, SE=Sweden, SI=Slovenia, SK=Slovakia, US= United States of America, CA=Canada.

For National Differences see attachment 1 of this test report.

 The product fulfils the requirements of EN 62368-1:2014+A11:2017.

**Copy of marking plate(s):**

The artwork below may be only a draft. The use of certification marks on a product must be authorized by the respective NCBS that own these marks.

MORNSUN

H0505S-1WR2-YG

● RoHS

YYWW

TEST ITEM PARTICULARS:	
Classification of use by .....	<input checked="" type="checkbox"/> Ordinary person <input type="checkbox"/> Instructed person <input type="checkbox"/> Skilled person <input type="checkbox"/> Children likely to be present
Supply Connection.....	<input type="checkbox"/> AC Mains <input type="checkbox"/> DC Mains <input checked="" type="checkbox"/> External Circuit - not Mains connected - <input checked="" type="checkbox"/> ES1 <input type="checkbox"/> ES2 <input type="checkbox"/> ES3
Supply % Tolerance .....	<input type="checkbox"/> +10%/-10% <input type="checkbox"/> +20%/-15% <input type="checkbox"/> +____%/ -____% <input checked="" type="checkbox"/> None
Supply Connection – Type .....	<input type="checkbox"/> pluggable equipment type A - <input type="checkbox"/> non-detachable supply cord <input type="checkbox"/> appliance coupler <input type="checkbox"/> direct plug-in <input type="checkbox"/> mating connector <input type="checkbox"/> pluggable equipment type B - <input type="checkbox"/> non-detachable supply cord <input type="checkbox"/> appliance coupler <input type="checkbox"/> permanent connection <input type="checkbox"/> mating connector <input checked="" type="checkbox"/> other: building-in
Considered current rating of protective device as part of building or equipment installation .....	Installation location: <input type="checkbox"/> building; <input checked="" type="checkbox"/> equipment
Equipment mobility .....	<input type="checkbox"/> movable <input type="checkbox"/> hand-held <input type="checkbox"/> transportable <input type="checkbox"/> stationary <input checked="" type="checkbox"/> for building-in <input type="checkbox"/> direct plug-in <input type="checkbox"/> rack-mounting <input type="checkbox"/> wall-mounted
Over voltage category (OVC) .....	<input type="checkbox"/> OVC I <input checked="" type="checkbox"/> OVC II (declared by client) <input type="checkbox"/> OVC III <input type="checkbox"/> OVC IV <input type="checkbox"/> other: _____
Class of equipment .....	<input type="checkbox"/> Class I <input type="checkbox"/> Class II <input checked="" type="checkbox"/> Class III
Access location .....	<input type="checkbox"/> restricted access location <input checked="" type="checkbox"/> N/A
Pollution degree (PD) .....	<input checked="" type="checkbox"/> PD 1 <input type="checkbox"/> PD 2 <input type="checkbox"/> PD 3
Manufacturer's specified maximum operating ambient .....	71°C (maximum load with output current), 85°C (10% load with output current).
IP protection class .....	<input checked="" type="checkbox"/> IPX0 <input type="checkbox"/> IP____
Power Systems .....	<input type="checkbox"/> TN <input type="checkbox"/> TT <input type="checkbox"/> IT - 230 V L-L
Altitude during operation (m) .....	<input checked="" type="checkbox"/> 2000 m or less <input type="checkbox"/> 5000 m
Altitude of test laboratory (m) .....	<input checked="" type="checkbox"/> 2000 m or less <input type="checkbox"/> _____ m
Mass of equipment (kg) .....	<input checked="" type="checkbox"/> Approx. 0.0044

<b>POSSIBLE TEST CASE VERDICTS:</b>	
- test case does not apply to the test object..... :	N/A
- test object does meet the requirement ..... :	P (Pass)
- test object does not meet the requirement ..... :	F (Fail)
<b>TESTING:</b>	
Date of receipt of test item..... :	Feb. 05, 2018
Date (s) of performance of tests..... :	Feb. 10, 2018 to Mar. 15, 2018
<b>GENERAL REMARKS:</b>	
<p>"(See Enclosure #)" refers to additional information appended to the report.                  "(See appended table)" refers to a table appended to the report.                  Throughout this report a <input type="checkbox"/> comma / <input checked="" type="checkbox"/> point is used as the decimal separator.</p>	
<b>Manufacturer's Declaration per sub-clause 4.2.5 of IEC60601-1:</b>	
The application for obtaining a CB Test Certificate includes more than one factory location and a declaration from the Manufacturer stating that the sample(s) submitted for evaluation is (are) representative of the products from each factory has been provided .....	<input type="checkbox"/> Yes <input checked="" type="checkbox"/> Not applicable
<b>When differences exist; they shall be identified in the General product information section.</b>	
<b>Name and address of factory (ies) .....</b>	Mornsun Guangzhou Science & Technology Co., Ltd. No. 8 Nanyun Road 4, Guangzhou Science Park, Guangzhou 510663, P.R. China
<b>GENERAL PRODUCT INFORMATION:</b>	
<p>1. The product with model name H0505S-1WR2-YG is a DC-DC Converter (for building-in type) for use with information technology equipment.</p> <p>2. The specified Max. ambient temperature is 71°C (full load with output current) and 85°C (10% load with output current).</p> <p>3. Reinforce or double insulation is provided between input circuit and output circuit and evaluation in this report is in the condition of below as requested by client:</p> <ol style="list-style-type: none"> <li>1) Working voltage between input circuit and output circuit: 1500Vdc</li> <li>2) Insulating compound material group of internal and bottom of enclosure: I.</li> <li>3) Isolation voltage: 4000VDC</li> </ol> <p>4. The product can pass 1.2 /50 µs, 6000V Impulse test according to Table F.5 of IEC 60664-1.</p>	

<b>ENERGY SOURCE IDENTIFICATION AND CLASSIFICATION TABLE:</b>	
(Note 1: Identify the following six (6) energy source forms based on the origin of the energy.) (Note 2: The identified classification e.g., ES2, TS1, should be with respect to its ability to cause pain or injury on the body or its ability to ignite a combustible material. Any energy source can be declared Class 3 as a worse case classification e.g. PS3, ES3.	
<b>Electrically-caused injury (Clause 5):</b> (Note: Identify type of source, list sub-assembly or circuit designation and corresponding energy source classification) Example: +5 V dc input <span style="float: right;">ES1</span>	
<b>Source of electrical energy</b>	<b>Corresponding classification (ES)</b>
All circuits	ES1
<b>Electrically-caused fire (Clause 6):</b> (Note: List sub-assembly or circuit designation and corresponding energy source classification) Example: Battery pack (maximum 85 watts): <span style="float: right;">PS2</span>	
<b>Source of power or PIS</b>	<b>Corresponding classification (PS)</b>
All circuits	PS1
<b>Injury caused by hazardous substances (Clause 7)</b> (Note: Specify hazardous chemicals, whether produces ozone or other chemical construction not addressed as part of the component evaluation.) Example: Liquid in filled component <span style="float: right;">Glycol</span>	
<b>Source of hazardous substances</b>	<b>Corresponding chemical</b>
N/A	None
<b>Mechanically-caused injury (Clause 8)</b> (Note: List moving part(s), fan, special installations, etc. & corresponding MS classification based on Table 35.) Example: Wall mount unit <span style="float: right;">MS2</span>	
<b>Source of kinetic/mechanical energy</b>	<b>Corresponding classification (MS)</b>
Built-in equipment	N/A
<b>Thermal burn injury (Clause 9)</b> (Note: Identify the surface or support, and corresponding energy source classification based on type of part, location, operating temperature and contact time in Table 38.) Example: Hand-held scanner – thermoplastic enclosure <span style="float: right;">TS1</span>	
<b>Source of thermal energy</b>	<b>Corresponding classification (TS)</b>
Built-in equipment	N/A
<b>Radiation (Clause 10)</b> (Note: List the types of radiation present in the product and the corresponding energy source classification.) Example: DVD – Class 1 Laser Product <span style="float: right;">RS1</span>	
<b>Type of radiation</b>	<b>Corresponding classification (RS)</b>
N/A	None



**ENERGY SOURCE DIAGRAM**

Indicate which energy sources are included in the energy source diagram. Insert diagram below

**ES1**

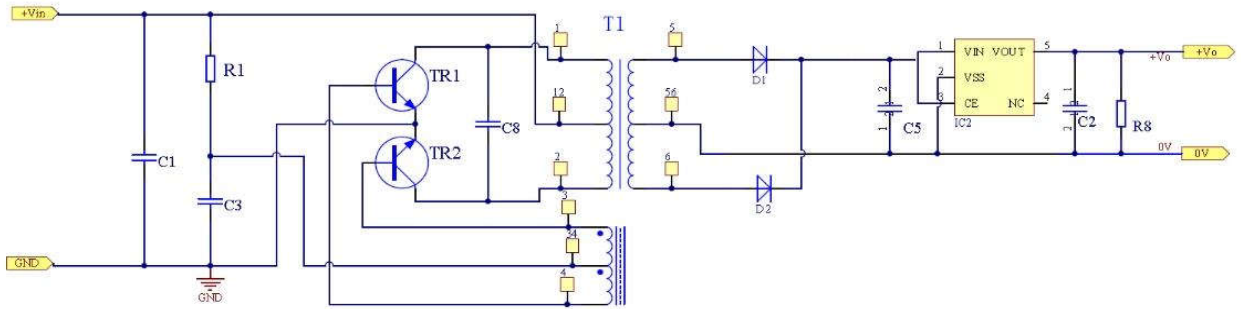

<b>OVERVIEW OF EMPLOYEDSAFEGUARDS</b>				
<b>Clause</b>	<b>Possible Hazard</b>			
5.1	Electrically-caused injury			
Body Part (e.g. Ordinary)	Energy Source (ES3: Primary Filter circuit)	Safeguards		
		Basic	Supplement ary	Reinforced (Enclosure)
Ordinary	ES1: All circuit	N/A	N/A	N/A
6.1	Electrically-caused fire			
Material part (e.g. mouse enclosure)	Energy Source	Safeguards		
		Basic	Supplement ary	Reinforced
All circuit	PS1 circuit	N/A	N/A	N/A
7.1	Injury caused by hazardous substances			
Body Part (e.g., skilled)	Energy Source (hazardous material)	Safeguards		
		Basic	Supplement ary	Reinforced
N/A	N/A	N/A	N/A	N/A
8.1	Mechanically-caused injury			
Body Part (e.g. Ordinary)	Energy Source (MS3:High Pressure Lamp)	Safeguards		
		Basic	Supplement ary	Reinforced (Enclosure)
Ordinary	Built-in equipment	N/A	N/A	N/A
9.1	Thermal Burn			
Body Part (e.g., Ordinary)	Energy Source (TS2)	Safeguards		
		Basic	Supplement ary	Reinforced
Ordinary	Built-in equipment	N/A	N/A	N/A
10.1	Radiation			
Body Part (e.g., Ordinary)	Energy Source (Output from audio port)	Safeguards		
		Basic	Supplement ary	Reinforced
N/A	N/A	N/A	N/A	N/A
Supplementary Information:				
(1) See attached energy source diagram for additional details.				
(2) "N" – Normal Condition; "A" – Abnormal Condition; "S" Single Fault				

IEC 62368-1			
Clause	Requirement + Test	Result - Remark	Verdict

<b>4</b>	<b>GENERAL REQUIREMENTS</b>		P
4.1.1	Acceptance of materials, components and subassemblies	See appended table 4.1.2	P
4.1.2	Use of components	Components which are certified to IEC and/or national standards are used correctly within their ratings. Components not covered by IEC standards are tested under the conditions present in the equipment. See also Annex G	P
4.1.3	Equipment design and construction	Evaluation of safeguards limiting the source supplying outputs to fulfill ES1, and protection in regard to risk of ignition, mechanical-caused injury and thermal burn considered.	P
4.1.15	Markings and instructions.....:	(See Annex F)	P
4.4.4	Safeguard robustness	See below.	P
4.4.4.2	Steady force tests.....:	Built-in equipment, shall be evaluated in end product.	N/A
4.4.4.3	Drop tests.....:	Built-in equipment, shall be evaluated in end product.	N/A
4.4.4.4	Impact tests.....:	Built-in equipment, shall be evaluated in end product.	N/A
4.4.4.5	Internal accessible safeguard enclosure and barrier tests.....:	The external enclosure cannot be opened without damaging the product.	N/A
4.4.4.6	Glass Impact tests.....:	No such glass used.	N/A
4.4.4.7	Thermoplastic material tests.....:	Built-in equipment, shall be evaluated in end product.	N/A
4.4.4.8	Air comprising a safeguard.....:	All circuit inside the equipment are PS1 source	N/A
4.4.4.9	Accessibility and safeguard effectiveness	All circuit inside the equipment are PS1 source	N/A
4.5	Explosion	No explosion occurs during normal/abnormal operation and single fault conditions	P
4.6	Fixing of conductors		N/A
4.6.1	Fix conductors not to defeat a safeguard	No such fix conductors used.	N/A
4.6.2	10 N force test applied to.....:	No such fix conductors used.	N/A
4.7	Equipment for direct insertion into mains socket - outlets	Not direct plug-in equipment.	N/A
4.7.2	Mains plug part complies with the relevant standard.....:	See above	N/A
4.7.3	Torque (Nm).....:	See above	N/A

IEC 62368-1			
Clause	Requirement + Test	Result - Remark	Verdict
4.8	Products containing coin/button cell batteries	No coin/button cell batteries used.	N/A
4.8.2	Instructional safeguard		N/A
4.8.3	Battery Compartment Construction		N/A
	Means to reduce the possibility of children removing the battery .....		—
4.8.4	Battery Compartment Mechanical Tests .....		N/A
4.8.5	Battery Accessibility		N/A
4.9	Likelihood of fire or shock due to entry of conductive object .....	Built-in equipment, shall be evaluated in end product.	N/A

<b>5</b>	<b>ELECTRICALLY-CAUSED INJURY</b>		<b>P</b>
5.2.1	Electrical energy source classifications .....	(See appended table 5.2)	P
5.2.2	ES1, ES2 and ES3 limits		P
5.2.2.2	Steady-state voltage and current .....	(See appended table 5.2)	P
5.2.2.3	Capacitance limits .....	No such capacitor used.	N/A
5.2.2.4	Single pulse limits .....	No such single pulses generated in the EUT or applied to it.	N/A
5.2.2.5	Limits for repetitive pulses .....	No such repetitive pulses within the EUT	N/A
5.2.2.6	Ringling signals .....	No such ringling signals within the EUT	N/A
5.2.2.7	Audio signals .....	No such audio signals	N/A
5.3	Protection against electrical energy sources	All circuits are ES1 circuit.	N/A
5.3.1	General Requirements for accessible parts to ordinary, instructed and skilled persons		N/A
5.3.2.1	Accessibility to electrical energy sources and safeguards		N/A
5.3.2.2	Contact requirements		N/A
	a) Test with test probe from Annex V .....		N/A
	b) Electric strength test potential (V) .....		N/A
	c) Air gap (mm) .....		N/A
5.3.2.4	Terminals for connecting stripped wire		N/A
5.4	Insulation materials and requirements		P
5.4.1.2	Properties of insulating material		P
5.4.1.3	Humidity conditioning .....	See sub-clause 5.4.8	P
5.4.1.4	Maximum operating temperature for insulating materials .....	See appended table 5.4.1.4, 6.3.2, 9.0, B.2.6.	P
5.4.1.5	Pollution degree .....	1	—
5.4.1.5.2	Test for pollution degree 1 environment and for an insulating compound	Complied.	P

IEC 62368-1			
Clause	Requirement + Test	Result - Remark	Verdict
5.4.1.5.3	Thermal cycling		P
5.4.1.6	Insulation in transformers with varying dimensions	No such transformer within the EUT	N/A
5.4.1.7	Insulation in circuits generating starting pulses	No such starting pulses within the EUT	N/A
5.4.1.8	Determination of working voltage	1500Vdc between input circuit and output circuit considered as requested by client. Pollution Degree 1 and Overvoltage Category II considered.	P
5.4.1.9	Insulating surfaces		N/A
5.4.1.10	Thermoplastic parts on which conductive metallic parts are directly mounted		N/A
5.4.1.10.2	Vicat softening temperature .....	Class III equipment.	N/A
5.4.1.10.3	Ball pressure .....	Class III equipment.	N/A
5.4.2	Clearances		P
5.4.2.2	Determining clearance using peak working voltage	(See appended table 5.4.2.2, 5.4.2.4 and 5.4.3)	P
5.4.2.3	Determining clearance using required withstand voltage .....	See above	N/A
	a) a.c. mains transient voltage .....		—
	b) d.c. mains transient voltage .....		—
	c) external circuit transient voltage.....		—
	d) transient voltage determined by measurement :		—
5.4.2.4	Determining the adequacy of a clearance using an electric strength test	Using procedure 1 to determine the clearance according to 5.4.2.2.	N/A
5.4.2.5	Multiplication factors for clearances and test voltages .....	Up to 2000m	N/A
5.4.3	Creepage distances.....	(See appended table 5.4.2.2, 5.4.2.4 and 5.4.3)	P
5.4.3.1	General		P
5.4.3.3	Material Group .....	Material group I is assumed to be used.	—
5.4.4	Solid insulation		P
5.4.4.2	Minimum distance through insulation .....	Enclosure provided as reinforced insulation.	P
5.4.4.3	Insulation compound forming solid insulation	Product inside filled with approved insulating compound.	P
5.4.4.4	Solid insulation in semiconductor devices		N/A
5.4.4.5	Cemented joints	No such construction within the EUT	N/A
5.4.4.6	Thin sheet material	See below	N/A
5.4.4.6.1	General requirements		N/A
5.4.4.6.2	Separable thin sheet material		N/A

IEC 62368-1			
Clause	Requirement + Test	Result - Remark	Verdict
	Number of layers (pcs) .....		N/A
5.4.4.6.3	Non-separable thin sheet material	No such insulation used within the EUT	N/A
5.4.4.6.4	Standard test procedure for non-separable thin sheet material.....		N/A
5.4.4.6.5	Mandrel test		N/A
5.4.4.7	Solid insulation in wound components		N/A
5.4.4.9	Solid insulation at frequencies >30 kHz .....		N/A
5.4.5	Antenna terminal insulation		N/A
5.4.5.1	General		N/A
5.4.5.2	Voltage surge test		N/A
	Insulation resistance (MΩ) .....		N/A
5.4.6	Insulation of internal wire as part of supplementary safeguard.....	No such insulation of internal wire as part of supplementary safeguard.	N/A
5.4.7	Tests for semiconductor components and for cemented joints	No tests necessary –see only 5.4.4.4.	N/A
5.4.8	Humidity conditioning		P
	Relative humidity (%) .....	95/%	—
	Temperature (°C) .....	40°C	—
	Duration (h) .....	120h	—
5.4.9	Electric strength test.....	See appended table 5.4.9.	P
5.4.9.1	Test procedure for a solid insulation type test		N/A
5.4.9.2	Test procedure for routine tests	No routine tests considered. To be considered during the relevant national approval.	N/A
5.4.10	Protection against transient voltages between external circuit	No such external circuits	N/A
5.4.10.1	Parts and circuits separated from external circuits		N/A
5.4.10.2	Test methods		N/A
5.4.10.2.1	General		N/A
5.4.10.2.2	Impulse test .....		N/A
5.4.10.2.3	Steady-state test .....		N/A
5.4.11	Insulation between external circuits and earthed circuitry .....	No such connections for external circuit applied within the EUT	N/A
5.4.11.1	Exceptions to separation between external circuits and earth	No such connections to external circuit as above.	N/A
5.4.11.2	Requirements		N/A
	Rated operating voltage $U_{op}$ (V) .....		—
	Nominal voltage $U_{peak}$ (V) .....		—
	Max increase due to variation $U_{sp}$ .....		—

IEC 62368-1			
Clause	Requirement + Test	Result - Remark	Verdict
	Max increase due to ageing $\Delta U_{sa}$ .....		—
	$U_{op} = U_{peak} + \Delta U_{sp} + \Delta U_{sa}$ .....		—
5.5	Components as safeguards		
5.5.1	General		P
5.5.2	Capacitors and RC units		N/A
5.5.2.1	General requirement		N/A
5.5.2.2	Safeguards against capacitor discharge after disconnection of a connector .....		N/A
5.5.3	Transformers	(See Annex G.5.3)	P
5.5.4	Optocouplers		N/A
5.5.5	Relays		N/A
5.5.6	Resistors		N/A
5.5.7	SPD's		N/A
5.5.7.1	Use of an SPD connected to reliable earthing		N/A
5.5.7.2	Use of an SPD between mains and protective earth		N/A
5.5.8	Insulation between the mains and external circuit consisting of a coaxial cable .....	No such external circuits.	N/A
5.6	Protective conductor		
5.6.2	Requirement for protective conductors		N/A
5.6.2.1	General requirements		N/A
5.6.2.2	Colour of insulation		N/A
5.6.3	Requirement for protective earthing conductors		N/A
	Protective earthing conductor size (mm <sup>2</sup> ) .....		—
5.6.4	Requirement for protective bonding conductors		N/A
5.6.4.1	Protective bonding conductors		N/A
	Protective bonding conductor size (mm <sup>2</sup> ).....		—
	Protective current rating (A) .....		—
5.6.4.3	Current limiting and overcurrent protective devices		N/A
5.6.5	Terminals for protective conductors		N/A
5.6.5.1	Requirement		N/A
	Conductor size (mm <sup>2</sup> ), nominal thread diameter (mm) .....		N/A
5.6.5.2	Corrosion		N/A
5.6.6	Resistance of the protective system		N/A
5.6.6.1	Requirements		N/A
5.6.6.2	Test Method Resistance .....		N/A

IEC 62368-1			
Clause	Requirement + Test	Result - Remark	Verdict
5.6.7	Reliable earthing		N/A
5.7	Prospective touch voltage, touch current and protective conductor current		N/A
5.7.2	Measuring devices and networks		N/A
5.7.2.1	Measurement of touch current .....		N/A
5.7.2.2	Measurement of prospective touch voltage		N/A
5.7.3	Equipment set-up, supply connections and earth connections		N/A
	System of interconnected equipment (separate connections/single connection) .....		—
	Multiple connections to mains (one connection at a time/simultaneous connections) .....		—
5.7.4	Earthed conductive accessible parts .....		N/A
5.7.5	Protective conductor current		N/A
	Supply Voltage (V) .....		—
	Measured current (mA) .....		—
	Instructional Safeguard .....		N/A
5.7.6	Prospective touch voltage and touch current due to external circuits	No external circuits.	N/A
5.7.6.1	Touch current from coaxial cables		N/A
5.7.6.2	Prospective touch voltage and touch current from external circuits		N/A
5.7.7	Summation of touch currents from external circuits	No external circuits.	N/A
	a) Equipment with earthed external circuits Measured current (mA) .....		N/A
	b) Equipment whose external circuits are not referenced to earth. Measured current (mA) .....		N/A

<b>6</b>	<b>ELECTRICALLY- CAUSED FIRE</b>		<b>P</b>
6.2	Classification of power sources (PS) and potential ignition sources (PIS)		<b>P</b>
6.2.2	Power source circuit classifications	PS (power source) classification determined by measuring the maximum power in Figures 34 and 35 for load and power source circuits.	<b>P</b>
6.2.2.1	General	See above.	<b>P</b>
6.2.2.2	Power measurement for worst-case load fault ... :	(See appended table 6.2.2)	<b>P</b>
6.2.2.3	Power measurement for worst-case power source fault .....	(See appended table 6.2.2)	<b>P</b>
6.2.2.4	PS1 .....	(See appended table 6.2.2)	<b>P</b>
6.2.2.5	PS2 .....		<b>N/A</b>
6.2.2.6	PS3 .....		<b>N/A</b>



IEC 62368-1			
Clause	Requirement + Test	Result - Remark	Verdict
6.2.3	Classification of potential ignition sources	No arcing PIS	N/A
6.2.3.1	Arcing PIS .....		N/A
6.2.3.2	Resistive PIS .....	No resistive PIS	N/A
6.3	Safeguards against fire under normal operating and abnormal operating conditions		P
6.3.1 (a)	No ignition and attainable temperature value less than 90 % defined by ISO 871 or less than 300 °C for unknown materials .....	No ignition and no such temperature attained within the equipment. (See appended table 5.4.1.4, 6.3.2, 9.0, B.2.6)	P
6.3.1 (b)	Combustible materials outside fire enclosure	Built-in equipment, shall be evaluated in end product.	N/A
6.4	Safeguards against fire under single fault conditions		N/A
6.4.1	Safeguard Method	Built-in equipment, shall be evaluated in end product.	N/A
6.4.2	Reduction of the likelihood of ignition under single fault conditions in PS1 circuits		N/A
6.4.3	Reduction of the likelihood of ignition under single fault conditions in PS2 and PS3 circuits	Built-in equipment, shall be evaluated in end product.	N/A
6.4.3.1	General	No PS2 and PS3 circuit.	N/A
6.4.3.2	Supplementary Safeguards		N/A
	Special conditions if conductors on printed boards are opened or peeled		N/A
6.4.3.3	Single Fault Conditions .....		N/A
	Special conditions for temperature limited by fuse		N/A
6.4.4	Control of fire spread in PS1 circuits		P
6.4.5	Control of fire spread in PS2 circuits	No PS2 circuit.	N/A
6.4.5.2	Supplementary safeguards .....	No PS2 and PS3 circuit.	N/A
6.4.6	Control of fire spread in PS3 circuit	No PS3 circuit.	N/A
6.4.7	Separation of combustible materials from a PIS	No PIS.	N/A
6.4.7.1	General .....	See above	N/A
6.4.7.2	Separation by distance		N/A
6.4.7.3	Separation by a fire barrier	No specific barrier provided.	N/A
6.4.8	Fire enclosures and fire barriers	No PS2 and PS3 circuit.	N/A
6.4.8.1	Fire enclosure and fire barrier material properties	No PS2 and PS3 circuit.	N/A
6.4.8.2.1	Requirements for a fire barrier	No fire barrier used.	N/A
6.4.8.2.2	Requirements for a fire enclosure		N/A
6.4.8.3	Constructional requirements for a fire enclosure and a fire barrier		N/A
6.4.8.3.1	Fire enclosure and fire barrier openings		N/A
6.4.8.3.2	Fire barrier dimensions		N/A
6.4.8.3.3	Top Openings in Fire Enclosure: dimensions(mm) .....	No PS2 and PS3 circuit.	N/A

IEC 62368-1			
Clause	Requirement + Test	Result - Remark	Verdict
	Needle Flame test		N/A
6.4.8.3.4	Bottom Openings in Fire Enclosure, condition met a), b) and/or c) dimensions (mm) .....	No PS2 and PS3 circuit.	N/A
	Flammability tests for the bottom of a fire enclosure .....	No PS2 and PS3 circuit.	N/A
6.4.8.3.5	Integrity of the fire enclosure, condition met: a), b) or c) .....	No PS2 and PS3 circuit.	N/A
6.4.8.4	Separation of PIS from fire enclosure and fire barrier distance (mm) or flammability rating .....	No PS2 and PS3 circuit.	N/A
6.5	Internal and external wiring		N/A
6.5.1	Requirements	No PS2 and PS3 circuit.	N/A
6.5.2	Cross-sectional area (mm <sup>2</sup> ) .....	See above	—
6.5.3	Requirements for interconnection to building wiring .....	No PS2 and PS3 circuit.	N/A
6.6	Safeguards against fire due to connection to additional equipment	No PS2 and PS3 circuit.	P
	External port limited to PS2 or complies with Clause Q.1	Output complies with Clause Q.1.	P

7	INJURY CAUSED BY HAZARDOUS SUBSTANCES		P
7.2	Reduction of exposure to hazardous substances	No hazardous chemicals within the equipment.	P
7.3	Ozone exposure	No ozone production within the equipment.	N/A
7.4	Use of personal safeguards (PPE)		N/A
	Personal safeguards and instructions .....		—
7.5	Use of instructional safeguards and instructions		N/A
	Instructional safeguard (ISO 7010) .....		—
7.6	Batteries.....	No battery used.	N/A

8	MECHANICALLY-CAUSED INJURY		N/A
8.1	General	Built-in equipment, shall be evaluated in end product.	N/A
8.2	Mechanical energy source classifications	Built-in equipment, shall be evaluated in end product.	N/A
8.3	Safeguards against mechanical energy sources		N/A
8.4	Safeguards against parts with sharp edges and corners	Built-in equipment, shall be evaluated in end product.	N/A
8.4.1	Safeguards		N/A
8.5	Safeguards against moving parts	No moving parts.	N/A

IEC 62368-1			
Clause	Requirement + Test	Result - Remark	Verdict
8.5.1	MS2 or MS3 part required to be accessible for the function of the equipment		N/A
8.5.2	Instructional Safeguard..... :		—
8.5.4	Special categories of equipment comprising moving parts		N/A
8.5.4.1	Large data storage equipment		N/A
8.5.4.2	Equipment having electromechanical device for destruction of media		N/A
8.5.4.2.1	Safeguards and Safety Interlocks .....		N/A
8.5.4.2.2	Instructional safeguards against moving parts		N/A
	Instructional Safeguard..... :		—
8.5.4.2.3	Disconnection from the supply		N/A
8.5.4.2.4	Probe type and force (N) .....		N/A
8.5.5	High Pressure Lamps		N/A
8.5.5.1	Energy Source Classification		N/A
8.5.5.2	High Pressure Lamp Explosion Test..... :		N/A
8.6	Stability	Built-in equipment, shall be evaluated in end product.	N/A
8.6.1	Product classification		N/A
	Instructional Safeguard..... :		—
8.6.2	Static stability		N/A
8.6.2.2	Static stability test		N/A
	Applied Force .....		—
8.6.2.3	Downward Force Test		N/A
8.6.3	Relocation stability test		N/A
	Unit configuration during 10° tilt .....		—
8.6.4	Glass slide test		N/A
8.6.5	Horizontal force test (Applied Force)..... :		N/A
	Position of feet or movable parts..... :		—
8.7	Equipment mounted to wall or ceiling		N/A
8.7.1	Mounting Means (Length of screws (mm) and mounting surface) .....		N/A
8.7.2	Direction and applied force..... :		N/A
8.8	Handles strength		N/A
8.8.1	Classification		N/A
8.8.2	Applied Force .....		N/A
8.9	Wheels or casters attachment requirements		N/A
8.9.1	Classification		N/A

IEC 62368-1			
Clause	Requirement + Test	Result - Remark	Verdict
8.9.2	Applied force .....		—
8.10	Carts, stands and similar carriers		N/A
8.10.1	General		N/A
8.10.2	Marking and instructions		N/A
	Instructional Safeguard .....		—
8.10.3	Cart, stand or carrier loading test and compliance		N/A
	Applied force .....		—
8.10.4	Cart, stand or carrier impact test		N/A
8.10.5	Mechanical stability		N/A
	Applied horizontal force (N) .....		—
8.10.6	Thermoplastic temperature stability (°C) .....		N/A
8.11	Mounting means for rack mounted equipment		N/A
8.11.1	General		N/A
8.11.2	Product Classification		N/A
8.11.3	Mechanical strength test, variable <i>N</i> .....		N/A
8.11.4	Mechanical strength test 250N, including end stops		N/A
8.12	Telescoping or rod antennas .....	No such parts.	N/A
	Button/Ball diameter (mm) .....		—

<b>9</b>	<b>THERMAL BURN INJURY</b>		N/A
9.2	Thermal energy source classifications	Built-in equipment, shall be evaluated in end product.	N/A
9.3	Safeguard against thermal energy sources	Built-in equipment, shall be evaluated in end product.	N/A
9.4	Requirements for safeguards		P
9.4.1	Equipment safeguard	Built-in equipment, shall be evaluated in end product.	N/A
9.4.2	Instructional safeguard .....	Built-in equipment, shall be evaluated in end product.	N/A

<b>10</b>	<b>RADIATION</b>		N/A
10.2	Radiation energy source classification		N/A
10.2.1	General classification		N/A
10.3	Protection against laser radiation		N/A
	Laser radiation that exists equipment:		—
	Normal, abnormal, single-fault .....		N/A
	Instructional safeguard .....		—
	Tool .....		—

IEC 62368-1			
Clause	Requirement + Test	Result - Remark	Verdict
10.4	Protection against visible, infrared, and UV radiation	No such radiation generated from the equipment.	N/A
10.4.1	General		N/A
10.4.1.a)	RS3 for Ordinary and instructed persons .....		N/A
10.4.1.b)	RS3 accessible to a skilled person.....		N/A
	Personal safeguard (PPE) instructional safeguard.....		—
10.4.1.c)	Equipment visible, IR, UV does not exceed RS1 .:		N/A
10.4.1.d)	Normal, abnormal, single-fault conditions .....		N/A
10.4.1.e)	Enclosure material employed as safeguard is opaque.....		N/A
10.4.1.f)	UV attenuation .....		N/A
10.4.1.g)	Materials resistant to degradation UV .....		N/A
10.4.1.h)	Enclosure containment of optical radiation.....		N/A
10.4.1.i)	Exempt Group under normal operating conditions.....		N/A
10.4.2	Instructional safeguard .....		N/A
10.5	Protection against x-radiation	No such x-radiation generated from the equipment	N/A
10.5.1	X- radiation energy source that exists equipment :		N/A
	Normal, abnormal, single fault conditions		N/A
	Equipment safeguards.....		N/A
	Instructional safeguard for skilled person .....		N/A
10.5.3	Most unfavourable supply voltage to give maximum radiation .....		—
	Abnormal and single-fault condition .....		N/A
	Maximum radiation (pA/kg).....		N/A
10.6	Protection against acoustic energy sources	Not such equipment.	N/A
10.6.1	General		N/A
10.6.2	Classification		N/A
	Acoustic output, dB(A) .....		N/A
	Output voltage, unweighted r.m.s.....		N/A
10.6.4	Protection of persons		N/A
	Instructional safeguards .....		N/A
	Equipment safeguard prevent ordinary person to RS2 .....		—
	Means to actively inform user of increase sound pressure.....		—
	Equipment safeguard prevent ordinary person to RS2.....		—
10.6.5	Requirements for listening devices (headphones,		N/A

IEC 62368-1			
Clause	Requirement + Test	Result - Remark	Verdict
	earphones, etc.)		
10.6.5.1	Corded passive listening devices with analog input		N/A
	Input voltage with 94 dB(A) $L_{Aeq}$ acoustic pressure output..... :		—
10.6.5.2	Corded listening devices with digital input		N/A
	Maximum dB(A)..... :		—
10.6.5.3	Cordless listening device		N/A
	Maximum dB(A)..... :		—

<b>B</b>	<b>NORMAL OPERATING CONDITION TESTS, ABNORMAL OPERATING CONDITION TESTS AND SINGLE FAULT CONDITION TESTS</b>		P
B.2	Normal Operating Conditions	See the following details.	P
B.2.1	General requirements..... :	(See summary of testing and appended table)	P
	Audio Amplifiers and equipment with audio amplifiers .....	Not such equipment.	N/A
B.2.3	Supply voltage and tolerances		N/A
B.2.5	Input test..... :	(See appended table B.2.5)	P
B.3	Simulated abnormal operating conditions		N/A
B.3.1	General requirements..... :	See clause B.4	N/A
B.3.2	Covering of ventilation openings	Built-in equipment, shall be evaluated in end product.	N/A
B.3.3	D.C. mains polarity test	The EUT is not connected to a D.C. mains	N/A
B.3.4	Setting of voltage selector .....	No voltage selector was used.	N/A
B.3.5	Maximum load at output terminals .....	No such terminal used.	N/A
B.3.6	Reverse battery polarity	No battery within the EUT	N/A
B.3.7	Abnormal operating conditions as specified in Clause E.2.	Not such equipment.	N/A
B.3.8	Safeguards functional during and after abnormal operating conditions		N/A
B.4	Simulated single fault conditions		P
B.4.2	Temperature controlling device open or short-circuited .....	No such device used.	N/A
B.4.3	Motor tests	No motors used.	N/A
B.4.3.1	Motor blocked or rotor locked increasing the internal ambient temperature .....		N/A
B.4.4	Short circuit of functional insulation	See below.	P
B.4.4.1	Short circuit of clearances for functional insulation	(See appended table B.4)	P
B.4.4.2	Short circuit of creepage distances for functional insulation	(See appended table B.4)	P

IEC 62368-1			
Clause	Requirement + Test	Result - Remark	Verdict
B.4.4.3	Short circuit of functional insulation on coated printed boards	No coated printed boards used.	N/A
B.4.5	Short circuit and interruption of electrodes in tubes and semiconductors	(See appended table B.4 for faults on electronic components)	P
B.4.6	Short circuit or disconnect of passive components	(See appended table B.4)	P
B.4.7	Continuous operation of components	The EUT is continuous operating type and no such components intended for short time operation or intermittent operation	N/A
B.4.8	Class 1 and Class 2 energy sources within limits during and after single fault conditions	No change to circuits classified in 5.3.	P
B.4.9	Battery charging under single fault conditions ... :	No battery involved in the EUT	N/A

<b>C</b>	<b>UV RADIATION</b>		N/A
C.1	Protection of materials in equipment from UV radiation	No UV generated from the equipment.	N/A
C.1.2	Requirements	See above.	N/A
C.1.3	Test method	See above.	N/A
C.2	UV light conditioning test	See above.	N/A
C.2.1	Test apparatus	See above.	N/A
C.2.2	Mounting of test samples	See above.	N/A
C.2.3	Carbon-arc light-exposure apparatus	See above.	N/A
C.2.4	Xenon-arc light exposure apparatus	See above.	N/A

<b>D</b>	<b>TEST GENERATORS</b>		N/A
D.1	Impulse test generators		N/A
D.2	Antenna interface test generator		N/A
D.3	Electronic pulse generator		N/A

<b>E</b>	<b>TEST CONDITIONS FOR EQUIPMENT CONTAINING AUDIO AMPLIFIERS</b>		N/A
E.1	Audio amplifier normal operating conditions	Not such equipment.	N/A
	Audio signal voltage (V) .....		--
	Rated load impedance ( $\Omega$ ) .....		--
E.2	Audio amplifier abnormal operating conditions		N/A

<b>F</b>	<b>EQUIPMENT MARKINGS, INSTRUCTIONS, AND INSTRUCTIONAL SAFEGUARDS</b>		P
F.1	General requirements	See below.	P
	Instructions – Language .....	English version provided. (Version in other language will be provided when submitted for national approval)	—
F.2	Letter symbols and graphical symbols		P

IEC 62368-1			
Clause	Requirement + Test	Result - Remark	Verdict
F.2.1	Letter symbols according to IEC60027-1	Letter symbols for quantities and units are complied with IEC 60027-1.	P
F.2.2	Graphic symbols IEC, ISO or manufacturer specific	Graphical symbols are complied with IEC 60417, ISO 3864-2, ISO 7000 or ISO 7010.	P
F.3	Equipment markings		P
F.3.1	Equipment marking locations	The required marking is located on the enclosure of the equipment and is easily visible.	P
F.3.2	Equipment identification markings	See copy of marking plate.	P
F.3.2.1	Manufacturer identification .....	See copy of marking plate.	—
F.3.2.2	Model identification .....	See copy of marking plate.	—
F.3.3	Equipment rating markings		P
F.3.3.1	Equipment with direct connection to mains	Not such equipment	N/A
F.3.3.2	Equipment without direct connection to mains	The input and output rating are indicated in user manual.	P
F.3.3.3	Nature of supply voltage.....	See above	—
F.3.3.4	Rated voltage .....	The input and output rating are indicated in user manual.	—
F.3.3.4	Rated frequency .....	DC supply	—
F.3.3.6	Rated current or rated power .....	The input and output rating are indicated in user manual.	—
F.3.3.7	Equipment with multiple supply connections	Only one supply connection provided.	N/A
F.3.4	Voltage setting device	No voltage setting device.	N/A
F.3.5	Terminals and operating devices	See below.	P
F.3.5.1	Mains appliance outlet and socket-outlet markings.....	No outlet used.	N/A
F.3.5.2	Switch position identification marking .....	No switch used.	N/A
F.3.5.3	Replacement fuse identification and rating markings.....	No fuse used.	N/A
F.3.5.4	Replacement battery identification marking .....	No such battery on the equipment.	N/A
F.3.5.5	Terminal marking location		N/A
F.3.6	Equipment markings related to equipment classification	Class III equipment	N/A
F.3.6.1	Class I Equipment		N/A
F.3.6.1.1	Protective earthing conductor terminal		N/A
F.3.6.1.2	Neutral conductor terminal		N/A
F.3.6.1.3	Protective bonding conductor terminals		N/A
F.3.6.2	Class II equipment (IEC60417-5172)		N/A
F.3.6.2.1	Class II equipment with or without functional earth		N/A



IEC 62368-1			
Clause	Requirement + Test	Result - Remark	Verdict
F.3.6.2.2	Class II equipment with functional earth terminal marking		N/A
F.3.7	Equipment IP rating marking .....	IPX0	—
F.3.8	External power supply output marking	No such power supply provided.	N/A
F.3.9	Durability, legibility and permanence of marking	Marking is considered to be legible and easily discernible. See also the following details.	P
F.3.10	Test for permanence of markings	The label was subjected to the permanence of marking test. The label was rubbed with cloth soaked with water for 15 sec. And then again for 15 seconds with the cloth soaked with petroleum spirit. After this test there was no damage to the label. The marking on the label did not fade. There was no curling and lifting of the label edge.  After each test, the marking remained legible.	P
F.4	Instructions		P
	a) Equipment for use in locations where children not likely to be present - marking		N/A
	b) Instructions given for installation or initial use		P
	c) Equipment intended to be fastened in place		N/A
	d) Equipment intended for use only in restricted access area		N/A
	e) Audio equipment terminals classified as ES3 and other equipment with terminals marked in accordance F.3.6.1	No such terminals provided.	N/A
	f) Protective earthing employed as safeguard		N/A
	g) Protective earthing conductor current exceeding ES2 limits		N/A
	h) Symbols used on equipment	No such symbols used as a safeguard considered.	N/A
	i) Permanently connected equipment not provided with all-pole mains switch	Built-in equipment, shall be evaluated in end product.	N/A
	j) Replaceable components or modules providing safeguard function	No such markings.	N/A
F.5	Instructional safeguards	No instructional safeguard is considered as necessary.	N/A
	Where “instructional safeguard” is referenced in the test report it specifies the required elements, location of marking and/or instruction	No instructional safeguard required in the equipment.	N/A
<b>G</b>	<b>COMPONENTS</b>		<b>P</b>
<b>G.1</b>	<b>Switches</b>		<b>N/A</b>

IEC 62368-1			
Clause	Requirement + Test	Result - Remark	Verdict
G.1.1	General requirements	No switch used.	N/A
G.1.2	Ratings, endurance, spacing, maximum load		N/A
<b>G.2</b>	<b>Relays</b>		N/A
G.2.1	General requirements	No relay used.	N/A
G.2.2	Overload test		N/A
G.2.3	Relay controlling connectors supply power		N/A
G.2.4	Mains relay, modified as stated in G.2		N/A
<b>G.3</b>	<b>Protection Devices</b>		P
G.3.1	Thermal cut-offs	No thermal cut-off used.	N/A
G.3.1.1a) &b)	Thermal cut-outs separately approved according to IEC 60730 with conditions indicated in a) & b)		N/A
G.3.1.1c)	Thermal cut-outs tested as part of the equipment as indicated in c)		N/A
G.3.1.2	Thermal cut-off connections maintained and secure		N/A
G.3.2	Thermal links		N/A
G.3.2.1a)	Thermal links separately tested with IEC 60691	No thermal link used.	N/A
G.3.2.1b)	Thermal links tested as part of the equipment		N/A
	Aging hours (H) .....		—
	Single Fault Condition .....		—
	Test Voltage (V) and Insulation Resistance ( $\Omega$ ) ..		—
G.3.3	PTC Thermistors	No PTC thermistor used.	N/A
G.3.4	Overcurrent protection devices		N/A
G.3.5	Safeguards components not mentioned in G.3.1 to G.3.4		N/A
G.3.5.1	Non-resettable devices suitably rated and marking provided	No such device used.	N/A
G.3.5.2	Single faults conditions.....	See above	N/A
<b>G.4</b>	<b>Connectors</b>		N/A
G.4.1	Spacings		N/A
G.4.2	Mains connector configuration .....		N/A
G.4.3	Plug is shaped that insertion into mains socket-outlets or appliance coupler is unlikely		N/A
<b>G.5</b>	<b>Wound Components</b>		P
G.5.1	Wire insulation in wound components.....	Approved TIW used for secondary winding of Transformer.	P
G.5.1.2 a)	Two wires in contact inside wound component, angle between 45° and 90°	No such contact.	P
G.5.1.2 b)	Construction subject to routine testing	See 5.4.9.2.	N/A
G.5.2	Endurance test on wound components	Not applied for.	N/A
G.5.2.1	General test requirements		N/A

IEC 62368-1			
Clause	Requirement + Test	Result - Remark	Verdict
G.5.2.2	Heat run test		N/A
	Time (s) .....		—
	Temperature (°C) .....		—
G.5.2.3	Wound Components supplied by mains		N/A
<b>G.5.3</b>	<b>Transformers</b>		P
G.5.3.1	Requirements applied (IEC61204-7, IEC61558-1/-2, and/or IEC62368-1).....	The transformer T1 meet the requirements given in G.5.3.2 and G.5.3.3.	P
	Position.....	T1	—
	Method of protection .....	See G.5.3.3.	—
G.5.3.2	Insulation	Input windings and output windings are separated by Reinforced insulation (The core is considered as intermediately part)	P
	Protection from displacement of windings.....	The end-turn of each winding is fixed by insulation tape	—
G.5.3.3	Overload test .....	(See appended table B.4)	P
G.5.3.3.1	Test conditions	Tested in the complete equipment.	P
G.5.3.3.2	Winding Temperatures testing in the unit	(See appended table B.4)	P
G.5.3.3.3	Winding Temperatures - Alternative test method	Alternative test method was not considered.	N/A
<b>G.5.4</b>	<b>Motors</b>		N/A
G.5.4.1	General requirements	No motor used.	N/A
	Position .....		—
G.5.4.2	Test conditions		N/A
G.5.4.3	Running overload test		N/A
G.5.4.4	Locked-rotor overload test		N/A
	Test duration (days) .....		—
G.5.4.5	Running overload test for d.c. motors in secondary circuits		N/A
G.5.4.5.2	Tested in the unit		N/A
	Electric strength test (V) .....		—
G.5.4.5.3	Tested on the Bench - Alternative test method; test time (h) .....		N/A
	Electric strength test (V) .....		—
G.5.4.6	Locked-rotor overload test for d.c. motors in secondary circuits		N/A
G.5.4.6.2	Tested in the unit		N/A
	Maximum Temperature .....		N/A
	Electric strength test (V) .....		N/A

IEC 62368-1			
Clause	Requirement + Test	Result - Remark	Verdict
G.5.4.6.3	Tested on the bench - Alternative test method; test time (h) .....		N/A
	Electric strength test (V) .....		N/A
G.5.4.7	Motors with capacitors		N/A
G.5.4.8	Three-phase motors		N/A
G.5.4.9	Series motors		N/A
	Operating voltage .....		—
<b>G.6</b>	<b>Wire Insulation</b>		P
G.6.1	General	Triple insulated winding in transformer T1 secondary windings used as reinforced safeguard in the isolating transformer that has separately complied with Annex J. See Appended table 4.1.2. No other wires other than Basic insulated wires not under stress used in the EUT.	P
G.6.2	Solvent-based enamel wiring insulation	Insulation does not rely on solvent-based enamel.	P
<b>G.7</b>	<b>Mains supply cords</b>		N/A
G.7.1	General requirements	No such cord provided	N/A
	Type.....		—
	Rated current (A).....		—
	Cross-sectional area (mm <sup>2</sup> ), (AWG).....		—
G.7.2	Compliance and test method		N/A
G.7.3	Cord anchorages and strain relief for non-detachable power supply cords		N/A
G.7.3.2	Cord strain relief		N/A
G.7.3.2.1	Requirements		N/A
	Strain relief test force (N) .....		—
G.7.3.2.2	Strain relief mechanism failure		N/A
G.7.3.2.3	Cord sheath or jacket position, distance (mm).....		—
G.7.3.2.4	Strain relief comprised of polymeric material		N/A
G.7.4	Cord Entry .....		N/A
G.7.5	Non-detachable cord bend protection		N/A
G.7.5.1	Requirements		N/A
G.7.5.2	Mass (g) .....		—
	Diameter (m) .....		—
	Temperature (?C).....		—
G.7.6	Supply wiring space		N/A
G.7.6.2	Stranded wire	No such wire.	N/A

IEC 62368-1			
Clause	Requirement + Test	Result - Remark	Verdict
G.7.6.2.1	Test with 8 mm strand		N/A
<b>G.8</b>	<b>Varistors</b>		N/A
G.8.1	General requirements		N/A
G.8.2	Safeguard against shock		N/A
G.8.3	Safeguard against fire		N/A
G.8.3.2	Varistor overload test .....		N/A
G.8.3.3	Temporary overvoltage .....		N/A
<b>G.9</b>	<b>Integrated Circuit (IC) Current Limiters</b>		N/A
G.9.1 a)	Manufacturer defines limit at max. 5A.	No IC current limiter provided within the equipment.	N/A
G.9.1 b)	Limiters do not have manual operator or reset		N/A
G.9.1 c)	Supply source does not exceed 250 VA .....		--
G.9.1 d)	IC limiter output current (max. 5A) .....		--
G.9.1 e)	Manufacturers' defined drift .....		--
G.9.2	Test Program 1		N/A
G.9.3	Test Program 2		N/A
G.9.4	Test Program 3		N/A
<b>G.10</b>	<b>Resistors</b>		N/A
G.10.1	General requirements		N/A
G.10.2	Resistor test		N/A
G.10.3	Test for resistors serving as safeguards between the mains and an external circuit consisting of a coaxial cable		N/A
G.10.3.1	General requirements		N/A
G.10.3.2	Voltage surge test		N/A
G.10.3.3	Impulse test		N/A
<b>G.11</b>	<b>Capacitor and RC units</b>		N/A
G.11.1	General requirements		N/A
G.11.2	Conditioning of capacitors and RC units		N/A
G.11.3	Rules for selecting capacitors		N/A
<b>G.12</b>	<b>Optocouplers</b>		N/A
	Optocouplers comply with IEC 60747-5-5:2007 Spacing or Electric Strength Test (specify option and test results) .....		N/A
	Type test voltage V <sub>ini</sub> .....		—
	Routine test voltage, V <sub>ini,b</sub> .....		—
<b>G.13</b>	<b>Printed boards</b>		N/A
G.13.1	General requirements	Only need to comply with functional insulation.	N/A

IEC 62368-1			
Clause	Requirement + Test	Result - Remark	Verdict
G.13.2	Uncoated printed boards		N/A
G.13.3	Coated printed boards		N/A
G.13.4	Insulation between conductors on the same inner surface		N/A
	Compliance with cemented joint requirements (Specify construction)..... :		—
G.13.5	Insulation between conductors on different surfaces		N/A
	Distance through insulation .....:		N/A
	Number of insulation layers (pcs) ..... :		—
G.13.6	Tests on coated printed boards		N/A
G.13.6.1	Sample preparation and preliminary inspection		N/A
G.13.6.2a)	Thermal conditioning		N/A
G.13.6.2b)	Electric strength test		N/A
G.13.6.2c)	Abrasion resistance test		N/A
<b>G.14</b>	<b>Coating on components terminals</b>		N/A
G.14.1	Requirements ..... :	No coating on component terminals considered to affect creepage or clearances.	N/A
<b>G.15</b>	<b>Liquid filled components</b>		N/A
G.15.1	General requirements	No such device provided within the equipment.	N/A
G.15.2	Requirements		N/A
G.15.3	Compliance and test methods		N/A
G.15.3.1	Hydrostatic pressure test		N/A
G.15.3.2	Creep resistance test		N/A
G.15.3.3	Tubing and fittings compatibility test		N/A
G.15.3.4	Vibration test		N/A
G.15.3.5	Thermal cycling test		N/A
G.15.3.6	Force test		N/A
G.15.4	Compliance		N/A
<b>G.16</b>	<b>IC including capacitor discharge function (ICX)</b>		N/A
a)	Humidity treatment in accordance with sc5.4.8 – 120 hours		N/A
b)	Impulse test using circuit 2 with $U_c =$ to transient voltage ..... :		N/A
C1)	Application of ac voltage at 110% of rated voltage for 2.5 minutes		N/A
C2)	Test voltage ..... :		—

IEC 62368-1			
Clause	Requirement + Test	Result - Remark	Verdict
D1)	10,000 cycles on and off using capacitor with smallest capacitance resistor with largest resistance specified by manufacturer		N/A
D2)	Capacitance .....		—
D3)	Resistance .....		—

H	CRITERIA FOR TELEPHONE RINGING SIGNALS		N/A
H.1	General	No telephone ringing signal generated within the equipment.	N/A
H.2	Method A		N/A
H.3	Method B		N/A
H.3.1	Ringling signal		N/A
H.3.1.1	Frequency (Hz) .....		—
H.3.1.2	Voltage (V) .....		—
H.3.1.3	Cadence; time (s) and voltage (V) .....		—
H.3.1.4	Single fault current (mA):.....		—
H.3.2	Tripping device and monitoring voltage .....		N/A
H.3.2.1	Conditions for use of a tripping device or a monitoring voltage complied with		N/A
H.3.2.2	Tripping device		N/A
H.3.2.3	Monitoring voltage (V) .....		—

J	INSULATED WINDING WIRES FOR USE WITHOUT INTERLEAVED INSULATION		P
	General requirements	Triple insulated winding wiring used as reinforced safeguard in the isolating transformer T1 that has been evaluated to Annex J as follows:  Requirements of Annex U of IEC 60950-1/A2 are identical to Annex J of this standard (for wires providing Reinforced insulation). See Table 4.1.2.	P

K	SAFETY INTERLOCKS		N/A
K.1	General requirements	No safety interlock provided.	N/A
K.2	Components of safety interlock safeguard mechanism .....		N/A
K.3	Inadvertent change of operating mode		N/A
K.4	Interlock safeguard override		N/A
K.5	Fail-safe		N/A
	Compliance .....		N/A
K.6	Mechanically operated safety interlocks		N/A

IEC 62368-1			
Clause	Requirement + Test	Result - Remark	Verdict
K.6.1	Endurance requirement		N/A
K.6.2	Compliance and Test method .....		N/A
K.7	Interlock circuit isolation		N/A
K.7.1	Separation distance for contact gaps & interlock circuit elements (type and circuit location) .....		N/A
K.7.2	Overload test, Current (A) .....		N/A
K.7.3	Endurance test		N/A
K.7.4	Electric strength test .....		N/A

L	DISCONNECT DEVICES		N/A
L.1	General requirements	Built-in equipment, shall be evaluated in end product.	N/A
L.2	Permanently connected equipment		N/A
L.3	Parts that remain energized		N/A
L.4	Single phase equipment		N/A
L.5	Three-phase equipment		N/A
L.6	Switches as disconnect devices		N/A
L.7	Plugs as disconnect devices	Built-in equipment, shall be evaluated in end product.	N/A
L.8	Multiple power sources	Only one a.c. mains connection.	N/A

M	EQUIPMENT CONTAINING BATTERIES AND THEIR PROTECTION CIRCUITS		N/A
M.1	General requirements	No battery used.	N/A
M.2	Safety of batteries and their cells		N/A
M.2.1	Requirements		N/A
M.2.2	Compliance and test method (identify method) .. :		--
M.3	Protection circuits		N/A
M.3.1	Requirements		N/A
M.3.2	Tests		N/A
	- Overcharging of a rechargeable battery		N/A
	- Unintentional charging of a non-rechargeable battery		N/A
	- Reverse charging of a rechargeable battery		N/A
	- Excessive discharging rate for any battery		N/A
M.3.3	Compliance .....		--
M.4	Additional safeguards for equipment containing secondary lithium battery		N/A
M.4.1	General		N/A
M.4.2	Charging safeguards		N/A



IEC 62368-1			
Clause	Requirement + Test	Result - Remark	Verdict
M.4.2.1	Charging operating limits		N/A
M.4.2.2a)	Charging voltage, current and temperature .....		--
M.4.2.2 b)	Single faults in charging circuitry .....		--
M.4.3	Fire Enclosure		N/A
M.4.4	Endurance of equipment containing a secondary lithium battery		N/A
M.4.4.2	Preparation		N/A
M.4.4.3	Drop and charge/discharge function tests		N/A
	Drop		N/A
	Charge		N/A
	Discharge		N/A
M.4.4.4	Charge-discharge cycle test		N/A
M.4.4.5	Result of charge-discharge cycle test		N/A
M.5	Risk of burn due to short circuit during carrying		N/A
M.5.1	Requirement		N/A
M.5.2	Compliance and Test Method (Test of P.2.3)		N/A
M.6	Prevention of short circuits and protection from other effects of electric current		N/A
M.6.1	Short circuits		N/A
M.6.1.1	General requirements		N/A
M.6.1.2	Test method to simulate an internal fault		N/A
M.6.1.3	Compliance (Specify M.6.1.2 or alternative method) .....		--
M.6.2	Leakage current (mA) .....		--
M.7	Risk of explosion from lead acid and NiCd batteries		N/A
M.7.1	Ventilation preventing explosive gas concentration		N/A
M.7.2	Compliance and test method		N/A
M.8	Protection against internal ignition from external spark sources of lead acid batteries		N/A
M.8.1	General requirements		N/A
M.8.2	Test method		N/A
M.8.2.1	General requirements		N/A
M.8.2.2	Estimation of hypothetical volume $V_z$ (m <sup>3</sup> /s).....		--
M.8.2.3	Correction factors.....		--
M.8.2.4	Calculation of distance $d$ (mm) .....		--
M.9	Preventing electrolyte spillage		N/A
M.9.1	Protection from electrolyte spillage		N/A

IEC 62368-1			
Clause	Requirement + Test	Result - Remark	Verdict
M.9.2	Tray for preventing electrolyte spillage		N/A
M.10	Instructions to prevent reasonably foreseeable misuse (Determination of compliance: inspection, data review; or abnormal testing) .....		N/A
<b>N</b>	<b>ELECTROCHEMICAL POTENTIALS</b>		N/A
	Metal(s) used .....	No risk of corrosion.	--
<b>O</b>	<b>MEASUREMENT OF CREEPAGE DISTANCES AND CLEARANCES</b>		P
	Figures O.1 to O.20 of this Annex applied .....	Considered.	—
<b>P</b>	<b>SAFEGUARDS AGAINST ENTRY OF FOREIGN OBJECTS AND SPILLAGE OF INTERNAL LIQUIDS</b>		N/A
P.1	General requirements	Built-in equipment, shall be evaluated in end product.	N/A
P.2.2	Safeguards against entry of foreign object		N/A
	Location and Dimensions (mm) .....	Built-in equipment, shall be evaluated in end product.	—
P.2.3	Safeguard against the consequences of entry of foreign object		N/A
P.2.3.1	Safeguards against the entry of a foreign object		N/A
	Openings in transportable equipment		N/A
	Transportable equipment with metalized plastic parts .....		N/A
P.2.3.2	Openings in transportable equipment in relation to metallized parts of a barrier or enclosure (identification of supplementary safeguard) .....		N/A
P.3	Safeguards against spillage of internal liquids	No such liquids.	N/A
P.3.1	General requirements		N/A
P.3.2	Determination of spillage consequences		N/A
P.3.3	Spillage safeguards		N/A
P.3.4	Safeguards effectiveness		N/A
P.4	Metallized coatings and adhesive securing parts	No such construction.	N/A
P.4.2 a)	Conditioning testing		N/A
	Tc (°C).....		—
	Tr (°C) .....		—
	Ta (°C).....		—
P.4.2 b)	Abrasion testing .....		N/A
P.4.2 c)	Mechanical strength testing .....		N/A

<b>IEC 62368-1</b>			
Clause	Requirement + Test	Result - Remark	Verdict
<b>Q</b>	<b>CIRCUITS INTENDED FOR INTERCONNECTION WITH BUILDING WIRING</b>		P
Q.1	Limited power sources	See appended table Annex Q.1	P
Q.1.1 a)	Inherently limited output		N/A
Q.1.1 b)	Impedance limited output		P
	- Regulating network limited output under normal operating and simulated single fault condition	A regulating network limits the output in compliance with table Q.1 both under normal operating conditions and after any single fault.	P
Q.1.1 c)	Overcurrent protective device limited output		N/A
Q.1.1 d)	IC current limiter complying with G.9		N/A
Q.1.2	Compliance and test method		P
Q.2	Test for external circuits – paired conductor cable	No such circuit for connection to the EUT	N/A
	Maximum output current (A) .....		--
	Current limiting method .....		--

<b>R</b>	<b>LIMITED SHORT CIRCUIT TEST</b>		N/A
R.1	General requirements	No such consideration.	N/A
R.2	Determination of the overcurrent protective device and circuit		N/A
R.3	Test method Supply voltage (V) and short-circuit current (A). .....		N/A

<b>S</b>	<b>TESTS FOR RESISTANCE TO HEAT AND FIRE</b>		N/A
S.1	Flammability test for fire enclosures and fire barrier materials of equipment where the steady state power does not exceed 4 000 W	Built-in equipment, shall be evaluated in end product.	N/A
	Samples, material .....		—
	Wall thickness (mm).....		—
	Conditioning (?C) .....		—
	Test flame according to IEC 60695-11-5 with conditions as set out		N/A
	- Material not consumed completely		N/A
	- Material extinguishes within 30s		N/A
	- No burning of layer or wrapping tissue		N/A
S.2	Flammability test for fire enclosure and fire barrier integrity		N/A
	Samples, material .....		—
	Wall thickness (mm).....		—
	Conditioning (?C) .....		—

IEC 62368-1			
Clause	Requirement + Test	Result - Remark	Verdict
	Test flame according to IEC 60695-11-5 with conditions as set out		N/A
	Test specimen does not show any additional hole		N/A
S.3	Flammability test for the bottom of a fire enclosure		N/A
	Samples, material .....		—
	Wall thickness (mm).....		—
	Cheesecloth did not ignite		N/A
S.4	Flammability classification of materials		N/A
S.5	Flammability test for fire enclosures and fire barrier materials of equipment where the steady state power does not exceed 4 000 W		N/A
	Samples, material .....		—
	Wall thickness (mm).....		—
	Conditioning (test condition), (°C).....		—
	Test flame according to IEC 60695-11-20 with conditions as set out		N/A
	After every test specimen was not consumed completely		N/A
	After fifth flame application, flame extinguished within 1 min		N/A

T	MECHANICAL STRENGTH TESTS		N/A
T.1	General requirements		N/A
T.2	Steady force test, 10 N .....	Built-in equipment, shall be evaluated in end product.	N/A
T.3	Steady force test, 30 N .....		N/A
T.4	Steady force test, 100 N .....	Built-in equipment, shall be evaluated in end product.	N/A
T.5	Steady force test, 250 N .....	Built-in equipment, shall be evaluated in end product.	N/A
T.6	Enclosure impact test	Built-in equipment, shall be evaluated in end product.	N/A
	Fall test	Built-in equipment, shall be evaluated in end product.	N/A
	Swing test	Built-in equipment, shall be evaluated in end product.	N/A
T.7	Drop test .....	Built-in equipment, shall be evaluated in end product.	N/A
T.8	Stress relief test .....	Built-in equipment, shall be evaluated in end product.	N/A
T.9	Impact Test (glass)	No glass used.	N/A
T.9.1	General requirements		N/A

IEC 62368-1			
Clause	Requirement + Test	Result - Remark	Verdict
T.9.2	Impact test and compliance		N/A
	Impact energy (J).....:		—
	Height (m) .....		—
T.10	Glass fragmentation test .....		N/A
T.11	Test for telescoping or rod antennas	No such antennas provided within the equipment.	N/A
	Torque value (Nm).....:		—
<b>U</b>	<b>MECHANICAL STRENGTH OF CATHODE RAY TUBES (CRT) AND PROTECTION AGAINST THE EFFECTS OF IMPLOSION</b>		N/A
U.1	General requirements	No CRT provided.	N/A
U.2	Compliance and test method for non-intrinsically protected CRTs		N/A
U.3	Protective Screen.....:		N/A
<b>V</b>	<b>DETERMINATION OF ACCESSIBLE PARTS (FINGERS, PROBES AND WEDGES)</b>		N/A
V.1	Accessible parts of equipment		N/A
V.2	Accessible part criterion		N/A

<b>IEC 62368-1</b>			
Clause	Requirement + Test	Result - Remark	Verdict
<b>4.8.4, 4.8.5</b>	<b>TABLE: Lithium coin/button cell batteries mechanical tests</b>		<b>N/A</b>
<b>(The following mechanical tests are conducted in the sequence noted.)</b>			
<b>4.8.4.2</b>	<b>TABLE: Stress Relief test</b>		—
	<b>Part</b>	<b>Material</b>	<b>Oven Temperature (°C)</b>
			<b>Comments</b>
<b>4.8.4.3</b>	<b>TABLE: Battery replacement test</b>		—
	Battery part no. ....:		—
	Battery Installation/withdrawal	Battery Installation/Removal Cycle	Comments
		1	
		2	
		3	
		4	
		5	
		6	
		8	
		9	
		10	
<b>4.8.4.4</b>	<b>TABLE: Drop test</b>		—
	Impact Area	Drop Distance	Drop No.
			1
			2
			3
<b>4.8.4.5</b>	<b>TABLE: Impact</b>		—
	Impacts per surface	Surface tested	Impact energy (Nm)
			<b>Comments</b>
<b>4.8.4.6</b>	<b>TABLE: Crush test</b>		—
	Test position	Surface tested	Crushing Force (N)
			<b>Duration force applied (s)</b>
Supplementary information:			

IEC 62368-1			
Clause	Requirement + Test	Result - Remark	Verdict

4.8.5	TABLE: Lithium coin/button cell batteries mechanical test result			N/A
Test position	Surface tested	Force (N)	Duration force applied (s)	

Supplementary information:

5.2	Table: Classification of electrical energy sources						P
5.2.2.2 – Steady State Voltage and Current conditions							
No.	Supply Voltage	Location (e.g. circuit designation)	Test conditions <sup>1)</sup>	Parameters			ES Class
				U (Vrms or Vpk)	I (Apk or Arms)	Hz	
1	5.5Vdc	Output + to -	Normal	5.003Vdc	--	--	ES1
			Abnormal	--	--	--	
			Single fault – SC/OC	--	--	--	
2	5.5Vdc	Transformer T1 Pin 5-Pin 56	Normal	7.9	--	--	ES1
			Abnormal	--	--	--	
			Single fault – SC/OC	--	--	--	
3	5.5Vdc	Transformer T1 Pin 6-Pin 56	Normal	7.9	--	--	ES1
			Abnormal	--	--	--	
			Single fault – SC/OC	--	--	--	

5.2.2.3 - Capacitance Limits							
No.	Supply Voltage	Location (e.g. circuit designation)	Test conditions	Parameters		ES Class	
				Capacitance, nF	Upk (V)		
			Normal	--	--	--	
			Abnormal	--	--	--	
			Single fault – SC/OC	--	--	--	

Overall capacity:

5.2.2.4 - Single Pulses							
No.	Supply Voltage	Location (e.g. circuit designation)	Test conditions	Parameters			ES Class
				Duration (ms)	Upk (V)	Ipk (mA)	
			Normal	--	--	--	
			Abnormal	--	--	--	
			Single fault – SC/OC			--	

5.2.2.5 - Repetitive Pulses

IEC 62368-1			
Clause	Requirement + Test		Result - Remark

No.	Supply Voltage	Location (e.g. circuit designation)	Test conditions	Parameters			ES Class
				Off time (ms)	Upk (V)	Ipk (mA)	
			Normal	--	--	--	
			Abnormal	--	--	--	
			Single fault – SC/OC			--	

Test Conditions: Normal – Full load and no load.

Abnormal – Overload output

Supplementary information: SC=Short Circuit, OC=Open Circuit .

5.4.1.4, 6.3.2, 9.0, B.2.6	TABLE: Temperature measurements	P
----------------------------	---------------------------------	---

Supply voltage (V) .....	A : 4.5 Vdc full load with output current B : 5.5 Vdc full load with output current C : 4.5 Vdc 10% load with output current D : 5.5 Vdc 10% load with output current				—
Ambient T <sub>min</sub> (°C) .....	--				—
Ambient T <sub>max</sub> (°C) .....	--				—
T <sub>ma</sub> (°C) .....	--				—
Maximum measured temperature T of part/at:	T (°C)				Allowed T <sub>max</sub> (°C)
	Test A	Test B	Test C	Test D	
Transformer T1 coil	78.2	85.7	87.8	89.5	110
Transformer T1 core	77.8	82.0	88.3	89.8	110
PCB near IC2	82.1	97.4	88.0	90.3	130
C2	77.7	88.3	87.1	88.8	130
PCB near D1	79.1	87.7	87.6	89.3	130
PCB near TR2	78.1	82.3	88.2	89.9	130
C1	76.9	80.2	88.0	89.6	130
Enclosure inside near transformer T1	76.7	81.2	87.5	88.8	130
Enclosure outside near transformer T1	75.1	78.2	86.9	87.9	130
Ambient	71.5	71.5	85.5	85.6	--

Supplementary information:

Note 1: The apparatus was submitted and evaluated for maximum manufacturer's recommended ambient (T<sub>ma</sub>) of 71°C with full output load and 85°C with 10% output load.

Note 2: The temperatures were measured under the worst case normal mode defined in clause B.2.1.

Temperature T of winding:	t <sub>1</sub> (°C)	R <sub>1</sub> (Ω)	t <sub>2</sub> (°C)	R <sub>2</sub> (Ω)	T (°C)	Allowed T <sub>max</sub> (°C)	Insulation class
--	--	--	--	--	--	--	--



IEC 62368-1			
Clause	Requirement + Test	Result - Remark	Verdict

Supplementary information:

5.4.1.10.2	TABLE: Vicat softening temperature of thermoplastics		N/A
Penetration (mm).....			—
Object/ Part No./Material	Manufacturer/trademark	T softening (°C)	
--	--	--	
supplementary information: --			

5.4.1.10.3	TABLE: Ball pressure test of thermoplastics			N/A
Allowed impression diameter (mm) .....	≤ 2 mm			—
Object/Part No./Material	Manufacturer/trademark	Test temperature (°C)	Impression diameter (mm)	
--	--	--	--	
Supplementary information:				

5.4.2.2, 5.4.2.4 and 5.4.3	TABLE: Minimum Clearances/Creepage distance						P
Clearance (cl) and creepage distance (cr) at/of/between:	Up (V)	U r.m.s. (V)	Frequency (kHz)	Required cl (mm)	cl (mm)	Required cr (mm)	cr (mm)
Input pins to output pins	1500#	1500#	42#	7.62	9.6	7.62	9.6
Supplementary information:							
Note 1: # the test data are declared by client.							
Note 2: See table 5.4.2.2 if this is based on peak working voltage							
Note 3: Material group I is assumed to be used.							

5.4.2.3	TABLE: Minimum Clearances distances using required withstand voltage			N/A
	Overvoltage Category (OV):		II	
	Pollution Degree:		2	
Clearance distanced between:	Required withstand voltage (V <sub>peak</sub> )	Required cl (mm)	Measured cl (mm)	
--	--	--	--	
Supplementary information:				

5.4.2.4	TABLE: Clearances based on electric strength test			N/A
Test voltage applied between:	Required cl (mm)	Test voltage (kV) peak/ r.m.s. / d.c.	Breakdown Yes / No	
--	--	--	--	
Supplementary information: Using procedure 1 to determine the clearance. F=Functional insulation, B= Basic insulation, R=Reinforced insulation.				

IEC 62368-1			
Clause	Requirement + Test	Result - Remark	Verdict

5.4.4.2, 5.4.4.5 c) 5.4.4.9	TABLE: Distance through insulation measurements					P
Distance through insulation di at/of:	Peak voltage (V)	Frequency (Hz)	Material	Required DTI (mm)	DTI (mm)	
Enclosure	1500	42K	Model: WH-9100 (Mfr.: WAH HONG INDUSTRIAL CORP)	0.4	0.5	
Supplementary information:						

5.4.9	TABLE: Electric strength tests				P
Test voltage applied between:	Voltage shape (AC, DC)	Test voltage (Vpeak)	Breakdown Yes / No		
Basic/supplementary:					
--	--	--	--		
Reinforced:					
Input to output	DC	4000	No		
Input to plastics enclosure with metal foil	DC	4000	No		
Transformer T1: Primary and secondary	DC	4000	No		
Transformer T1: Secondary and core	DC	4000	No		
Supplementary information:					
The DC voltage source was performed on all testing once in forward and once in reverse.					

5.5.2.2	TABLE: Stored discharge on capacitors					N/A
Supply Voltage (V), Hz	Test Location	Operating Condition (N, S)	Switch position On or off	Measured Voltage (after 2 seconds)	ES Classification	
--	Phase to Neutral	--	--	--	--	
Supplementary information:						
X-capacitors installed for testing are:						
<input type="checkbox"/> bleeding resistor rating:						
<input type="checkbox"/> ICX:						
Notes:						
A. Test Location:						
Phase to Neutral; Phase to Phase; Phase to Earth; and/or Neutral to Earth						
B. Operating condition abbreviations:						
N – Normal operating condition (e.g., normal operation, or open fuse); S –Single fault condition						

IEC 62368-1			
Clause	Requirement + Test	Result - Remark	Verdict

5.6.6.2	TABLE: Resistance of protective conductors and terminations				N/A
Accessible part	Test current (A)	Duration (min)	Voltage drop (V)	Resistance (Ω)	
--	--	--	--	--	
Supplementary Information:					

5.7.2.2, 5.7.4	TABLE: Earthed accessible conductive part		N/A
Supply voltage .....			—
Location	Test conditions specified in 6.1 of IEC 60990 or Fault Condition No in IEC 60990 clause 6.2.2.1 through 6.2.2.8, except for 6.2.2.7		Touch current (mA)
	1		
	2*		
	3		
	4		
	5		
	6		
	8		
Supplementary Information:			
Notes:			
[1] Supply voltage is the anticipated maximum Touch Voltage			
[2] Earthed neutral conductor [Voltage differences less than 1% or more]			
[3] Specify method used for measurement as described in IEC 60990 sub-clause 4.3			
[4] IEC60990, sub-clause 6.2.2.7, Fault 7 not applicable.			
[5] (*) IEC60990, sub-clause 6.2.2.2 is not applicable if switch or disconnect device (e.g., appliance coupler) provided.			

6.2.2	Table: Electrical power sources (PS) measurements for classification				P
Source	Description	Measurement	Max Power after 3 s	Max Power after 5 s	PS Classification
Output	Normal condition	Power (W) :	--	1.22	PS1
		V <sub>A</sub> (V) :	--	5.003	
		I <sub>A</sub> (A) :	--	0.27	
Output	Abnormal condition (TR2 b-c S-C**)	Power (W) :	--	0	PS1
		V <sub>A</sub> (V) :	--	0	
		I <sub>A</sub> (A) :	--	0	
Output	Abnormal condition	Power (W) :	--	0	PS1
		V <sub>A</sub> (V) :	--	0	

IEC 62368-1					
Clause	Requirement + Test			Result - Remark	Verdict
	(TR2 b-e S-C*)	I <sub>A</sub> (A) :	--	0	
Output	Abnormal condition (TR2 c-e S-C**)	Power (W) :	--	0	PS1
		V <sub>A</sub> (V) :	--	0	
		I <sub>A</sub> (A) :	--	0	
Output	Abnormal condition (D1 S-C*)	Power (W) :	--	0	PS1
		V <sub>A</sub> (V) :	--	0	
		I <sub>A</sub> (A) :	--	0	
Output	Abnormal condition (IC2 Pin 1-2 S-C*)	Power (W) :	--	0	PS1
		V <sub>A</sub> (V) :	--	0	
		I <sub>A</sub> (A) :	--	0	
Output	Abnormal condition (IC2 Pin 1-5 S-C)	Power (W) :	--	2.28	PS1
		V <sub>A</sub> (V) :	--	7.14	
		I <sub>A</sub> (A) :	--	0.45	
Supplementary Information:					
Input voltage: 5.5Vdc					
S-C=Short circuit.					
*Unit shutdown immediately recoverable, no hazard.					
**Unit shutdown, TR1and TR2 damaged, unrecoverable.					

6.2.3.1	Table: Determination of Potential Ignition Sources (Arcing PIS)				N/A
Location	Open circuit voltage After 3 s (V <sub>p</sub> )	Measured r.m.s current (I <sub>rms</sub> )	Calculated value (V <sub>p</sub> x I <sub>rms</sub> )	Arcing PIS? Yes / No	
--	--	--	--	Yes	
Supplementary information:					

6.2.3.2	Table: Determination of Potential Ignition Sources (Resistive PIS)				N/A
Circuit Location (x-y)	Operating Condition (Normal / Describe Single Fault)	Measured wattage or VA During first 30 s (W / VA)	Measured wattage or VA After 30 s (W / VA)	Protective Circuit, Regulator, or PTC Operated? Yes / No (Comment)	Resistive PIS? Yes/No
All internal circuits/components	--	--	--	--	Yes (declaration)

IEC 62368-1			
Clause	Requirement + Test	Result - Remark	Verdict

Supplementary Information: No resistive PIS

A combination of voltmeter, VA and ammeter IA may be used instead of a wattmeter.

If a separate voltmeter and ammeter are used, the product of (VA x IA) is used to determine Resistive PIS classification.

A Resistive PIS: (a) dissipates more than 15 W, measured after 30 s of normal operation, or (b) under single fault conditions has either a power exceeding 100 W measured immediately after the introduction of the fault if electronic circuits, regulators or PTC devices are used, or has an available power exceeding 15 W measured 30 s after introduction of the fault.

8.5.5	TABLE: High Pressure Lamp			N/A
Description	Values		Energy Source Classification	
Lamp type.....:			—	
Manufacturer .....			—	
Cat no. ....:			—	
Pressure (cold) (MPa).....:			MS_	
Pressure (operating) (MPa) .....			MS_	
Operating time (minutes) .....			—	
Explosion method .....			—	
Max particle length escaping enclosure (mm) .:			MS_	
Max particle length beyond 1 m (mm).....:			MS_	
Overall result .....				
Supplementary information:				

B.2.5	TABLE: Input test						P
U (V)	I (A)	I <sub>rated</sub> (A)	P (W)	Fuse #	I <sub>fuse</sub> (A)	Condition/status	
4.5	0.28	0.33	1.26	--	--	Loaded with 5.0Vdc, 0.2A	
5.0	0.28	--	1.40	--	--	Loaded with 5.0Vdc, 0.2A	
5.5	0.29	0.33	1.60	--	--	Loaded with 5.0Vdc, 0.2A	
Supplementary information:							
The maximum measured current under rated voltage did not exceed 110% of the rated current.							

B.3	TABLE: Abnormal operating condition tests								N/A
Ambient temperature (°C) .....									—
Power source for EUT: Manufacturer, model/type, output rating .:									—
Component No.	Abnormal Condition	Supply voltage, (V)	Test time (ms)	Fuse no.	Fuse current, (A)	T-couple	Temp. (°C)	Observation	
Supplementary information: see Table B.4									

IEC 62368-1			
Clause	Requirement + Test	Result - Remark	Verdict

B.4		TABLE: Fault condition tests						P
Ambient temperature (°C) .....		25.1°C, if not specified						—
Power source for EUT: Manufacturer, model/type, output rating .:		--						—
Component No.	Abnormal Condition	Supply voltage, (V)	Test time (ms)	Fuse no.	Fuse current, (A)	T-couple	Temp. (°C)	Observation
TR2 Pin b-e	s-c	5.5	10mins	--	0.29→0	--	--	Unit shut down, recoverable, no hazards
TR2 Pin c-e	s-c	5.5	1s	--	0.29→0	--	--	Unit shut down, TR1 and TR2 damaged, unrecoverable.
TR2 Pin b-c	s-c	5.5	1s	--	0.29→0	--	--	Unit shut down, TR1 and TR2 damaged, unrecoverable.
Transformer T1 Pin 5-56	s-c	5.5	10mins	--	0.29→ 0.06	--	--	Unit shut down, recoverable, no hazards
Transformer T1 Pin 6-56	s-c	5.5	10mins	--	0.29→ 0.06	--	--	Unit shut down, recoverable, no hazards
Transformer T1 Pin 1-12	s-c	5.5	10mins	--	0.29→ 0.07	--	--	Unit shut down, recoverable, no hazards
Transformer T1 Pin 2-12	s-c	5.5	10mins	--	0.29→ 0.07	--	--	Unit shut down, recoverable, no hazards
Transformer T1 Pin 3-34	s-c	5.5	10mins	--	0.29→ 0.28	--	--	Unit works as normal, no hazard.
Transformer T1 Pin 4-34	s-c	5.5	10mins	--	0.29→ 0.28	--	--	Unit works as normal, no hazard.
IC2 Pin 1-2	s-c	5.5	10mins	--	0.29→ 0.08→0. 13	--	--	Unit shut down, recoverable, no hazards.

IEC 62368-1								
Clause	Requirement + Test					Result - Remark		Verdict
IC2 Pin 1-5	s-c	5.5	10mins	--	0.29	--	--	Output voltage rise from 4.9V to 6.4V, Output current is constant, Recoverable, no hazards.
D1	s-c	5.5	10mins	--	0.29→ 0.08	--	--	Unit shut down, recoverable, no hazards
Output	s-c	5.5	10mins	--	0.29→ 0.06	--	--	Unit shut down, recoverable, no hazards
Output	o-l	5.5	3hours1 2mins	--	0.048→ 0.287→ 0.353→ 0.069	Type J	Transformer T1 Coil: 105.3°C Transformer T1 Core: 101.4°C Ambient: 85.5°C	When unit output overload to more than 0.27A, Output shut down immediately, no hazards.

**Supplementary information:**

Test table is provided to record abnormal and fault conditions for all applicable energy sources including Thermal burn injury. Column "Abnormal/Fault." Specify if test condition by indicating "Abnormal" then the condition for a Clause B.3 test or "Single Fault" then the condition for Clause B.4.

1) s-c: Short-circuited; o-c: Open-circuited; o-l: Overloaded.

2) The test result shown all safeguards remained effective and didn't lead to a single fault condition during abnormal operating condition; In addition all safeguards complied with applicable requirements in this standard after restoration of normal operating conditions.

3) The test result showed no Class 1 or 2 energy source become Class 3 level during and after single fault condition.

Annex M	TABLE: Batteries								N/A	
The tests of Annex M are applicable only when appropriate battery data is not available										
Is it possible to install the battery in a reverse polarity position?..... :										
	Non-rechargeable batteries			Rechargeable batteries						
	Discharging		Un-intentional charging	Charging		Discharging		Reversed charging		
	Meas. current	Manuf. Specs.		Meas. current	Manuf. Specs.	Meas. current	Manuf. Specs.	Meas. current	Manuf. Specs.	
Max. current during normal condition										
Max. current during fault condition										
Test results:										
									Verdict	

IEC 62368-1			
Clause	Requirement + Test	Result - Remark	Verdict
	- Chemical leaks		
	- Explosion of the battery		
	- Emission of flame or expulsion of molten metal		
	- Electric strength tests of equipment after completion of tests		
Supplementary information:			

Annex M.4	Table: Additional safeguards for equipment containing secondary lithium batteries				N/A
Battery/Cell No.	Test conditions	Measurements			Observation
		U	I (A)	Temp (C)	
	Normal				
	Abnormal				
	Single fault –SC/OC				
Supplementary Information:					
Battery identification	Charging at $T_{lowest}$ (°C)	Observation	Charging at $T_{highest}$ (°C)	Observation	
Supplementary Information:					

Annex Q.1	TABLE: Circuits intended for interconnection with building wiring (LPS)					P
Note: Measured UOC (V) with all load circuits disconnected:						
Output Circuit	Components	U <sub>oc</sub> (V)	I <sub>sc</sub> (A)		S (VA)	
			Meas.	Limit	Meas.	Limit
Output	Output normal	5.003	0.27	8	1.22	100
Output	TR2 b-c S-C**	0	0	8	0	100
Output	TR2 b-e S-C*	0	0	8	0	100
Output	TR2 c-e S-C**	0	0	8	0	100
Output	D1 S-C*	0	0	8	0	100
Output	IC2 Pin 1-2 S-C*	0	0	8	0	100
Output	IC2 Pin 1-5 S-C	7.14	0.45	8	2.28	100
Supplementary Information: S-C: Short-circuited *Unit shutdown immediately recoverable, no hazard. **Unit shutdown, TR1and TR2 damaged, unrecoverable.						



IEC 62368-1			
Clause	Requirement + Test	Result - Remark	Verdict

T.2, T.3, T.4, T.5	TABLE: Steady force test					N/A
Part/Location	Material	Thickness (mm)	Force (N)	Test Duration (sec)	Observation	
Supplementary information:						

T.6, T.9	TABLE: Impact tests				N/A
Part/Location	Material	Thickness (mm)	Vertical distance (mm)	Observation	
Supplementary information:					

T.7	TABLE: Drop tests				N/A
Part/Location	Material	Thickness (mm)	Drop Height (mm)	Observation	
Supplementary information:					

T.8	TABLE: Stress relief test					N/A
Part/Location	Material	Thickness (mm)	Oven Temperature (°C)	Duration (h)	Observation	
Supplementary information:						

IEC62368_1B ATTACHMENT			
Clause	Requirement + Test	Result - Remark	Verdict

<b>ATTACHMENT TO TEST REPORT IEC 62368-1</b> <b>EUROPEAN GROUP DIFFERENCES AND NATIONAL DIFFERENCES</b> (Audio/video, information and communication technology equipment - Part 1: Safety requirements)			
<b>Differences according to</b> .....: EN 62368-1:2014+A11:2017			
<b>Attachment Form No.</b> ....: EU_GD_IEC62368_1B_II			
<b>Attachment Originator</b> .....: Nemko AS			
<b>Master Attachment</b> .....: Date 2017-09-22			
<b>Copyright © 2017 IEC System for Conformity Testing and Certification of Electrical Equipment (IECEE), Geneva, Switzerland. All rights reserved.</b>			

CENELEC COMMON MODIFICATIONS (EN)						
Clauses, subclauses, notes, tables, figures and annexes which are additional to those in IEC 62368-1:2014 are prefixed "Z".						
CONTENTS	<b>Add</b> the following annexes: Annex ZA (normative) Normative references to international publications with their corresponding European publications Annex ZB (normative) Special national conditions Annex ZC (informative) A-deviations Annex ZD (informative) IEC and CENELEC code designations for flexible cords					P
	<b>Delete</b> all the "country" notes in the reference document (IEC 62368-1:2014) according to the following list:					P
	0.2.1	Note	1	Note 3	4.1.15	Note
	4.7.3	Note 1 and 2	5.2.2.2	Note	5.4.2.3.2.2 Table 13	Note c
	5.4.2.3.2.4	Note 1 and 3	5.4.2.5	Note 2	5.4.5.1	Note
	5.5.2.1	Note	5.5.6	Note	5.6.4.2.1	Note 2 and 3
	5.7.5	Note	5.7.6.1	Note 1 and 2	10.2.1 Table 39	Note 2, 3 and 4
	10.5.3	Note 2	10.6.2.1	Note 3	F.3.3.6	Note 3
	For special national conditions, see Annex ZB.					P
1	<b>Add</b> the following note: NOTE Z1 The use of certain substances in electrical and electronic equipment is restricted within the EU: see Directive 2011/65/EU.					P

IEC62368_1B ATTACHMENT			
Clause	Requirement + Test	Result - Remark	Verdict
4.Z1	<p><b>Add</b> the following new subclause after 4.9:</p> <p>To protect against excessive current, short-circuits and earth faults in circuits connected to an a.c. <b>mains</b>, protective devices shall be included either as integral parts of the equipment or as parts of the building installation, subject to the following, a), b) and c):</p> <p>a) except as detailed in b) and c), protective devices necessary to comply with the requirements of B.3.1 and B.4 shall be included as parts of the equipment;</p> <p>b) for components in series with the mains input to the equipment such as the supply cord, appliance coupler, r.f.i. filter and switch, short-circuit and earth fault protection may be provided by protective devices in the building installation;</p> <p>c) it is permitted for <b>pluggable equipment type B</b> or <b>permanently connected equipment</b>, to rely on dedicated overcurrent and short-circuit protection in the building installation, provided that the means of protection, e.g. fuses or circuit breakers, is fully specified in the installation instructions.</p> <p>If reliance is placed on protection in the building installation, the installation instructions shall so state, except that for <b>pluggable equipment type A</b> the building installation shall be regarded as providing protection in accordance with the rating of the wall socket outlet.</p>	Not connected to an a.c. mains.	N/A
5.4.2.3.2.4	<p><b>Add</b> the following to the end of this subclause:</p> <p>The requirement for interconnection with <b>external circuit</b> is in addition given in EN 50491-3:2009.</p>	No connection to external circuit.	N/A
10.2.1	<p>Add the following to c) and d) in table 39:</p> <p>For additional requirements, see 10.5.1.</p>	No radiation.	N/A

IEC62368_1B ATTACHMENT			
Clause	Requirement + Test	Result - Remark	Verdict
10.5.1	<p><b>Add</b> the following after the first paragraph: <i>For RS 1 compliance is checked by measurement under the following conditions:</i></p> <p><i>In addition to the normal operating conditions, all controls adjustable from the outside by hand, by any object such as a tool or a coin, and those internal adjustments or presets which are not locked in a reliable manner, are adjusted so as to give maximum radiation whilst maintaining an intelligible picture for 1 h, at the end of which the measurement is made.</i></p> <p>NOTE Z1 Soldered joints and paint lockings are examples of adequate locking.</p> <p><i>The dose-rate is determined by means of a radiation monitor with an effective area of 10 cm<sup>2</sup>, at any point 10 cm from the outer surface of the apparatus.</i></p> <p><i>Moreover, the measurement shall be made under fault conditions causing an increase of the high-voltage, provided an intelligible picture is maintained for 1 h, at the end of which the measurement is made.</i></p> <p><i>For RS1, the dose-rate shall not exceed 1 μSv/h taking account of the background level.</i></p> <p>NOTE Z2 These values appear in Directive 96/29/Euratom of 13 May 1996.</p>	Added.	N/A
10.6.1	<p><b>Add</b> the following paragraph to the end of the subclause: EN 71-1:2011, 4.20 and the related tests methods and measurement distances apply.</p>	Added.	N/A
10.Z1	<p><b>Add</b> the following new subclause after 10.6.5. <b>10.Z1 Non-ionizing radiation from radio frequencies in the range 0 to 300 GHz</b></p> <p>The amount of non-ionizing radiation is regulated by European Council Recommendation 1999/519/EC of 12 July 1999 on the limitation of exposure of the general public to electromagnetic fields (0 Hz to 300 GHz).</p> <p>For intentional radiators, ICNIRP guidelines should be taken into account for Limiting Exposure to Time-Varying Electric, Magnetic, and Electromagnetic Fields (up to 300 GHz). For hand-held and body-mounted devices, attention is drawn to EN 50360 and EN 50566</p>	Added. The equipment is a low power DC-DC Converter, it does incorporate only non-intentional radiators, but does not contain radio transmitters; the typical usage, installation and physical characteristics make the equipment inherently compliant with all applicable EMF exposure levels (EN 62479:2010 clause 4.1 Route A).	N/A
G.7.1	<p><b>Add</b> the following note: NOTE Z1 The harmonized code designations corresponding to the IEC cord types are given in Annex ZD.</p>	Added.	N/A

IEC62368_1B ATTACHMENT			
Clause	Requirement + Test	Result - Remark	Verdict
Bibliography	<p><b>Add</b> the following standards:</p> <p><b>Add</b> the following notes for the standards indicated:</p> <p>IEC 60130-9 NOTE Harmonized as EN 60130-9.            IEC 60269-2 NOTE Harmonized as HD 60269-2.            IEC 60309-1 NOTE Harmonized as EN 60309-1.            IEC 60364 NOTE some parts harmonized in HD 384/HD 60364 series.            IEC 60601-2-4 NOTE Harmonized as EN 60601-2-4.            IEC 60664-5 NOTE Harmonized as EN 60664-5.            IEC 61032:1997 NOTE Harmonized as EN 61032:1998 (not modified).            IEC 61508-1 NOTE Harmonized as EN 61508-1.            IEC 61558-2-1 NOTE Harmonized as EN 61558-2-1.            IEC 61558-2-4 NOTE Harmonized as EN 61558-2-4.            IEC 61558-2-6 NOTE Harmonized as EN 61558-2-6.            IEC 61643-1 NOTE Harmonized as EN 61643-1.            IEC 61643-21 NOTE Harmonized as EN 61643-21.            IEC 61643-311 NOTE Harmonized as EN 61643-311.            IEC 61643-321 NOTE Harmonized as EN 61643-321.            IEC 61643-331 NOTE Harmonized as EN 61643-331.</p>		P
<b>ZB</b>	<b>ANNEX ZB, SPECIAL NATIONAL CONDITIONS (EN)</b>		--
4.1.15	<p><b>Denmark, Finland, Norway and Sweden</b></p> <p>To the end of the subclause the following is added:</p> <p><b>Class I pluggable equipment type A</b> intended for connection to other equipment or a network shall, if safety relies on connection to reliable earthing or if surge suppressors are connected between the network terminals and <b>accessible</b> parts, have a marking stating that the equipment shall be connected to an earthed <b>mains</b> socket-outlet.</p> <p>The marking text in the applicable countries shall be as follows:</p> <p>In <b>Denmark</b>: "Apparatets stikprop skal tilsluttes en stikkontakt med jord som giver forbindelse til stikproppens jord."            In <b>Finland</b>: "Laite on liitettävä suojakoskettimilla varustettuun pistorasiaan"            In <b>Norway</b>: "Apparatet må tilkoples jordet stikkontakt"            In <b>Sweden</b>: "Apparaten skall anslutas till jordat uttag"</p>	<p>Added.</p> <p>Class III equipment.</p>	N/A
4.7.3	<p><b>United Kingdom</b></p> <p>To the end of the subclause the following is added:</p> <p>The torque test is performed using a socket-outlet complying with BS 1363, and the plug part shall be assessed to the relevant clauses of BS 1363. Also see Annex G.4.2 of this annex</p>		N/A

IEC62368_1B ATTACHMENT			
Clause	Requirement + Test	Result - Remark	Verdict
5.2.2.2	<p><b>Denmark</b></p> <p>After the 2nd paragraph add the following: A warning (marking <b>safeguard</b>) for high <b>touch current</b> is required if the <b>touch current</b> exceeds the limits of 3,5 mA a.c. or 10 mA d.c.</p>	No high touch current measured.	N/A
5.4.11.1 and Annex G	<p><b>Finland and Sweden</b></p> <p>To the end of the subclause the following is added: For separation of the telecommunication network from earth the following is applicable: If this insulation is solid, including insulation forming part of a component, it shall at least consist of either</p> <ul style="list-style-type: none"> <li>• two layers of thin sheet material, each of which shall pass the electric strength test below, or</li> <li>• one layer having a distance through insulation of at least 0,4 mm, which shall pass the electric strength test below.</li> </ul> <p>If this insulation forms part of a semiconductor component (e.g. an optocoupler), there is no distance through insulation requirement for the insulation consisting of an insulating compound completely filling the casing, so that clearances and creepage distances do not exist, if the component passes the electric strength test in accordance with the compliance clause below and in addition</p> <ul style="list-style-type: none"> <li>• passes the tests and inspection criteria of 5.4.8 with an electric strength test of 1,5 kV multiplied by 1,6 (the electric strength test of 5.4.9 shall be performed using 1,5 kV), and</li> <li>• is subject to routine testing for electric strength during manufacturing, using a test voltage of 1,5kV.</li> </ul> <p>It is permitted to bridge this insulation with a capacitor complying with EN 60384-14:2005, subclass Y2.</p> <p>A capacitor classified Y3 according to EN 60384-14:2005, may bridge this insulation under the following conditions:</p> <ul style="list-style-type: none"> <li>• the insulation requirements are satisfied by having a capacitor classified Y3 as defined by EN 60384-14, which in addition to the Y3 testing, is tested with an impulse test of 2,5 kV defined in 5.4.11;</li> <li>• the additional testing shall be performed on all the test specimens as described in EN 60384-14;</li> </ul> <p>the impulse test of 2,5 kV is to be performed before the endurance test in EN 60384-14, in the sequence of tests as described in EN 60384-14.</p>	No connection to such a network.	N/A

IEC62368_1B ATTACHMENT			
Clause	Requirement + Test	Result - Remark	Verdict
5.5.2.1	<p><b>Norway</b></p> <p>After the 3rd paragraph the following is added: Due to the IT power system used, capacitors are required to be rated for the applicable line-to-line voltage (230 V).</p>		N/A
5.5.6	<p><b>Finland, Norway and Sweden</b></p> <p>To the end of the subclause the following is added: Resistors used as <b>basic safeguard</b> or bridging <b>basic insulation in class I pluggable equipment type A</b> shall comply with G.10.1 and the test of G.10.2.</p>	No such resistor used.	N/A
5.6.1	<p><b>Denmark</b></p> <p><b>Add</b> to the end of the subclause</p> <p>Due to many existing installations where the socket-outlets can be protected with fuses with higher rating than the rating of the socket-outlets the protection for pluggable equipment type A shall be an integral part of the equipment.</p> <p><i>Justification:</i> In Denmark an existing 13 A socket outlet can be protected by a 20 A fuse.</p>	Added.	N/A
5.6.4.2.1	<p><b>Ireland and United Kingdom</b></p> <p>After the indent for <b>pluggable equipment type A</b>, the following is added: – the <b>protective current rating</b> is taken to be 13 A, this being the largest rating of fuse used in the <b>mains</b> plug.</p>	Added.	N/A
5.6.5.1	<p>To the second paragraph the following is added: The range of conductor sizes of flexible cords to be accepted by terminals for equipment with a rated current over 10 A and up to and including 13 A is: 1,25 mm<sup>2</sup> to 1,5 mm<sup>2</sup> in cross-sectional area.</p>	Added.	N/A
5.7.5	<p><b>Denmark</b></p> <p>To the end of the subclause the following is added: The installation instruction shall be affixed to the equipment if the <b>protective conductor current</b> exceeds the limits of 3,5 mA a.c. or 10 mA d.c.</p>		N/A

IEC62368_1B ATTACHMENT			
Clause	Requirement + Test	Result - Remark	Verdict
5.7.6.1	<p><b>Norway and Sweden</b></p> <p>To the end of the subclause the following is added: The screen of the television distribution system is normally not earthed at the entrance of the building and there is normally no equipotential bonding system within the building. Therefore the protective earthing of the building installation needs to be isolated from the screen of a cable distribution system.</p> <p>It is however accepted to provide the insulation external to the equipment by an adapter or an interconnection cable with galvanic isolator, which may be provided by a retailer, for example.</p> <p>The user manual shall then have the following or similar information in Norwegian and Swedish language respectively, depending on in what country the equipment is intended to be used in: “Apparatus connected to the protective earthing of the building installation through the mains connection or through other apparatus with a connection to protective earthing – and to a television distribution system using coaxial cable, may in some circumstances create a fire hazard. Connection to a television distribution system therefore has to be provided through a device providing electrical isolation below a certain frequency range (galvanic isolator, see EN 60728-11)”</p> <p>NOTE In Norway, due to regulation for CATV-installations, and in Sweden, a galvanic isolator shall provide electrical insulation below 5 MHz. The insulation shall withstand a dielectric strength of 1,5 kV r.m.s., 50 Hz or 60 Hz, for 1 min.</p> <p>Translation to Norwegian (the Swedish text will also be accepted in Norway): “Apparater som er koplet til beskyttelsesjord via nettplugg og/eller via annet jordtilkoplet utstyr – og er tilkoplet et koaksialbasert kabel-TV nett, kan forårsake brannfare. For å unngå dette skal det ved tilkopling av apparater til kabel-TV nett installeres en galvanisk isolator mellom apparatet og kabel-TV nettet.”</p> <p>Translation to Swedish: ”Apparater som är kopplad till skyddsjord via jordat vägguttag och/eller via annan utrustning och samtidigt är kopplad till kabel-TV nät kan i vissa fall medföra risk för brand. För att undvika detta skall vid anslutning av apparaten till kabel-TV nät galvanisk isolator finnas mellan apparaten och kabel-TV nätet.”</p>		N/A



IEC62368_1B ATTACHMENT			
Clause	Requirement + Test	Result - Remark	Verdict
5.7.6.2	<p><b>Denmark</b></p> <p>To the end of the subclause the following is added: The warning (marking safeguard) for high touch current is required if the touch current or the protective current exceed the limits of 3,5 mA .</p>		N/A
B.3.1 and B.4	<p><b>Ireland and United Kingdom</b></p> <p>The following is applicable: To protect against excessive currents and short-circuits in the primary circuit of <b>direct plug-in equipment</b>, tests according to Annexes B.3.1 and B.4 shall be conducted using an external miniature circuit breaker complying with EN 60898-1, Type B, rated 32A. If the equipment does not pass these tests, suitable protective devices shall be included as an integral part of the <b>direct plug-in equipment</b>, until the requirements of Annexes B.3.1 and B.4 are met</p>	Not direct plug-in equipment.	N/A
G.4.2	<p><b>Denmark</b></p> <p>To the end of the subclause the following is added: Supply cords of single phase appliances having a rated current not exceeding 13 A shall be provided with a plug according to DS 60884-2-D1:2011. CLASS I EQUIPMENT provided with socket-outlets with earth contacts or which are intended to be used in locations where protection against indirect contact is required according to the wiring rules shall be provided with a plug in accordance with standard sheet DK 2-1a or DK 2-5a. If a single-phase equipment having a RATED CURRENT exceeding 13 A or if a poly-phase equipment is provided with a supply cord with a plug, this plug shall be in accordance with the standard sheets DK 6-1a in DS 60884-2-D1 or EN 60309-2. Mains socket outlets intended for providing power to Class II apparatus with a rated current of 2,5 A shall be in accordance DS 60884-2-D1:2011 standard sheet DKA 1-4a. Other current rating socket outlets shall be in compliance with Standard Sheet DKA 1-3a or DKA 1-1c. Mains socket-outlets with earth shall be in compliance with DS 60884-2-D1:2011 Standard Sheet DK 1-3a, DK 1-1c, DK1-1d, DK 1-5a or DK 1-7a <i>Justification:</i> Heavy Current Regulations, Section 6c</p>		N/A

IEC62368_1B ATTACHMENT			
Clause	Requirement + Test	Result - Remark	Verdict
G.4.2	<p><b>United Kingdom</b></p> <p>To the end of the subclause the following is added: The plug part of direct plug-in equipment shall be assessed to BS 1363: Part 1, 12.1, 12.2, 12.3, 12.9, 12.11, 12.12, 12.13, 12.16, and 12.17, except that the test of 12.17 is performed at not less than 125 °C. Where the metal earth pin is replaced by an Insulated Shutter Opening Device (ISOD), the requirements of clauses 22.2 and 23 also apply.</p>		N/A
G.7.1	<p><b>United Kingdom</b></p> <p>To the first paragraph the following is added: Equipment which is fitted with a flexible cable or cord and is designed to be connected to a mains socket conforming to BS 1363 by means of that flexible cable or cord shall be fitted with a 'standard plug' in accordance with the Plugs and Sockets etc (Safety) Regulations 1994, Statutory Instrument 1994 No. 1768, unless exempted by those regulations.</p> <p>NOTE "Standard plug" is defined in SI 1768:1994 and essentially means an approved plug conforming to BS 1363 or an approved conversion plug.</p>		N/A
G.7.1	<p><b>Ireland</b></p> <p>To the first paragraph the following is added: Apparatus which is fitted with a flexible cable or cord shall be provided with a plug in accordance with Statutory Instrument 525: 1997, "13 A Plugs and Conversion Adapters for Domestic Use Regulations: 1997. S.I. 525 provides for the recognition of a standard of another Member State which is equivalent to the relevant Irish Standard</p>		N/A
G.7.2	<p><b>Ireland and United Kingdom</b></p> <p>To the first paragraph the following is added: A power supply cord with a conductor of 1,25 mm<sup>2</sup> is allowed for equipment which is rated over 10 A and up to and including 13 A.</p>		N/A

IEC62368_1B ATTACHMENT			
Clause	Requirement + Test	Result - Remark	Verdict
ZC	ANNEX ZC, NATIONAL DEVIATIONS (EN)		--
10.5.2	<p><b>Germany</b></p> <p>The following requirement applies:            For the operation of any cathode ray tube intended for the display of visual images operating at an acceleration voltage exceeding 40 kV, authorization is required, or application of type approval (Bauartzulassung) and marking.</p> <p><i>Justification:</i>            German ministerial decree against ionizing radiation (Röntgenverordnung), in force since 2002-07-01, implementing the European Directive 96/29/EURATOM.</p> <p><b>NOTE</b> Contact address:            Physikalisch-Technische Bundesanstalt, Bundesallee 100,            D-38116 Braunschweig,            Tel.: Int +49-531-592-6320,            Internet: <a href="http://www.ptb.de">http://www.ptb.de</a></p>		N/A

IEC62368_1B ATTACHMENT			
Clause	Requirement + Test	Result - Remark	Verdict

<b>ATTACHMENT TO TEST REPORT IEC 62368-1 2<sup>th</sup> Ed.</b> <b>U.S.A. NATIONAL DIFFERENCES</b> Audio/video, information and communication technology equipment – Part 1: Safety requirements	
<b>Differences according to.....:</b>	CSA/UL 62368-1:2014
<b>Attachment Form No.....:</b>	US&CA_ND_IEC623681B
<b>Attachment Originator.....:</b>	UL(US)
<b>Master Attachment.....:</b>	Date 2015-06
<b>Copyright © 2015 IEC System for Conformity Testing and Certification of Electrical Equipment (IECEE), Geneva, Switzerland. All rights reserved.</b>	

<b>IEC 62368-1 - US and Canadian National Differences</b> <b>Special National Conditions based on Regulations and Other National Differences</b>			
1.1	All equipment is to be designed to allow installation according to the National Electrical Code (NEC), ANSI/NFPA 70, the Canadian Electrical Code (CEC), Part I, CAN/CSA C22.1, and when applicable, the National Electrical Safety Code, IEEE C2. Also, for such equipment marked or otherwise identified, installation is allowed per the Standard for the Protection of Information Technology Equipment, ANSI/NFPA 75.		P
1.4	Additional requirements apply to some forms of power distribution equipment, including sub-assemblies.		P
4.1.17	For lengths exceeding 3.05 m, external interconnecting flexible cord and cable assemblies are required to be a suitable cable type (e.g., DP, CL2) specified in the NEC.		N/A
	For lengths 3.05 m or less, external interconnecting flexible cord and cable assemblies that are not types specified in the NEC generally are required to have special construction features and identification markings.		N/A
4.8	Lithium coin / button cell batteries have modified special construction and performance requirements.		N/A
5.6.3	Protective earthing conductors comply with the minimum conductor sizes in Table G.5, except as required by Table G.7ADV.1 for cord connected equipment, or Annex DVH for permanently connected equipment	Class III equipment.	N/A

IEC62368_1B ATTACHMENT			
Clause	Requirement + Test	Result - Remark	Verdict
5.7.7	Equipment intended to receive telecommunication ringing signals complies with a special touch current measurement tests.	Not such equipment	N/A
6.5.1	PS3 wiring outside a fire enclosure complies with single fault testing in B.4, or be current limited per one of the permitted methods.	No such PS3 wire.	N/A
Annex F (F.3.3.8)	Output terminals provided for supply of other equipment, except mains, supply are marked with a maximum rating or references to which equipment it is permitted to be connected.		N/A
Annex G (G.7.1)	Permanent connection of equipment to the mains supply by a power supply cord is not permitted, except for certain equipment, such as ATMs.		N/A
Annex G (G.7.3)	Power supply cords are required to have attachment plugs rated not less than 125 percent of the rated current of the equipment.		N/A
	Flexible power supply cords are required to be compatible with Article 400 of the NEC, and Tables 11 and 12 of the CEC.		N/A
Annex G (G.7.5)	Minimum cord length is required to be 1.5 m, with certain constructions such as external power supplies allowed to consider both input and output cord lengths into the requirement. Power supply cords are required to be no longer than 4.5 m in length if used in ITE Rooms.		N/A
Annex H.2	Continuous ringing signals under normal operating conditions up to 16 mA only are permitted if the equipment is subjected to special installation and performance restrictions.		N/A
Annex H.4	For circuits with other than ringing signals and with voltages exceeding 42.4 V <sub>peak</sub> or 60 V d.c., the maximum acceptable current through a 2000 ohm resistor (or greater) connected across the voltage source with other loads disconnected is 7.1 mA peak or 30 mA d.c. under normal operating conditions.		N/A
Annex M	Battery packs for stationary applications comply with special component requirements.	No battery.	N/A
Annex DVA (1)	Equipment intended for use in spaces used for environmental air are subjected to special flammability requirements for heat and visible smoke release.	Not such equipment or application.	N/A

IEC62368_1B ATTACHMENT			
Clause	Requirement + Test	Result - Remark	Verdict
	For ITE room applications, automated information storage systems with combustible media greater than 0.76 m <sup>3</sup> (27 cu ft) have a provision for connection of either automatic sprinklers or a gaseous agent extinguishing system with an extended discharge.		N/A
	Consumer products designed or intended primarily for children 12 years of age or younger are subject to additional requirements in accordance with U.S. & Canadian Regulations.		N/A
	Baby monitors additionally comply with ASTM F2951, Consumer Safety Specification for Baby Monitors.		N/A
Annex DVA (5.6.3)	For Pluggable Equipment Type A, the protection in the installation is assumed to be 20A.		N/A
Annex DVA (6.3)	The maximum quantity of flammable liquid stored in equipment complies with NFPA 30.		N/A
Annex DVA (6.4.8)	For ITE room applications, enclosures with combustible material measuring greater than 0.9 m <sup>2</sup> (10 sq ft) or a single dimension greater than 1.8 m (6 ft) have a flame spread rating of 50 or less. For equipment with the same dimensions for other applications, an external surface that is not a fire enclosure requires a min. flammability classification of V-1.		N/A
Annex DVA (10.3.1)	Equipment with lasers meets the U.S. Code of Federal Regulations 21 CFR 1040 (and the Canadian Radiation Emitting Devices Act, REDR C1370).		N/A
Annex DVA (10.5.1)	Equipment that produces ionizing radiation complies with the U.S. Code of Federal Regulations, 21 CFR 1020 (and the Canadian Radiation Emitting Devices Act, REDR C1370).		N/A
Annex DVA (F.3.3.3)	Equipment for use on a.c. mains supply systems with a neutral and more than one phase conductor (e.g. 120/240 V, 3-wire) require a special marking format for electrical ratings. Additional considerations apply for voltage ratings that exceed the attachment cap rating or are lower than the "Normal Operating Condition" in Table 2 of CAN/CSA C22.2 No. 235."		N/A
Annex DVA (F.3.3.5)	Equipment identified for ITE (computer) room installation is marked with the rated current		N/A
Annex DVA (G.1)	Vertically-mounted disconnect switches and circuit breakers have the "on" position indicated by the handle in the up position		N/A

IEC62368_1B ATTACHMENT			
Clause	Requirement + Test	Result - Remark	Verdict
Annex DVA (G.3.4)	Suitable NEC/CEC branch circuit protection rated at the maximum circuit rating is required for all standard supply outlets and receptacles (such as supplied in power distribution units) if the supply branch circuit protection is not suitable.		N/A
Annex DVA (G.4.2)	Equipment with isolated ground (earthing) receptacles complies with NEC 250.146(D) and CEC 10-112 and 10-906(8).		N/A
Annex DVA (G.4.3)	Where a fuse is used to provide Class 2 or Class 3 current limiting, it is not operator-accessible unless it is non- interchangeable.	No such fuse provided.	N/A
Annex DVA (G.5.3)	Power distribution transformers distributing power at 100 volts or more, and rated 10 kVA or more, require special transformer overcurrent protection.		N/A
Annex DVA (G.5.4)	Motor control devices are required for cord-connected equipment with a mains-connected motor if the equipment is rated more than 12 A, or if the equipment has a nominal voltage rating greater than 120 V, or if the motor is rated more than 1/3 hp (locked rotor current over 43 A).		N/A
Annex DVA (Annex M)	For ITE room applications, equipment with battery systems capable of supplying 750 VA for five minutes have a battery disconnect means that may be connected to the ITE room remote power-off circuit.		N/A
Annex DVA (Q)	Wiring terminals intended to supply Class 2 outputs according to the NEC or CEC Part 1 are marked with the voltage rating and "Class 2" or equivalent; marking is located adjacent to the terminals and visible during wiring.		N/A
Annex DVB (1)	Additional requirements apply for equipment used for entertainment purposes intended for installation in general patient care areas of health care facilities.		N/A
Annex DVC (1)	Additional requirements apply for equipment intended for mounting under kitchen cabinets.		N/A

IEC62368_1B ATTACHMENT			
Clause	Requirement + Test	Result - Remark	Verdict
Annex DVE (4.1.1)	Some equipment, components, sub-assemblies and materials associated with the risk of fire, electric shock, or personal injury have component or material ratings in accordance with the applicable national (U.S. and Canadian) component or material requirements. Components required to comply include: appliance couplers, attachment plugs, battery back-up systems, battery packs, circuit breakers, communication circuit accessories, connectors (used for current interruption of non-LPS circuits), power supply cords, direct plug-in equipment, electrochemical capacitor modules (energy storage modules with ultra-capacitors), enclosures (outdoor), flexible cords and cables, fuses (branch circuit), ground-fault current interrupters, interconnecting cables, data storage equipment, printed wiring, protectors for communications circuits, receptacles, surge protective devices, vehicle battery adapters, wire connectors, and wire and cables.	See Table 4.1.2.	P
Annex DVH	Equipment for permanent connection to the mains supply is subjected to additional requirements.		N/A
Annex DVH (DVH.1)	Wiring methods (terminals, leads, etc.) used for the connection of the equipment to the mains are in accordance with the NEC/CEC.		N/A
Annex DVH (DVH.3.2)	Terminals for permanent wiring, including protective earthing terminals, are suitable for U.S./Canadian wire gauge sizes, rated 125 percent of the equipment rating, and are specially marked when specified.		N/A
Annex DVH (DVH.3.2)	Wire binding screws are not permitted to attach conductors larger than 10 AWG (5.3 mm <sup>2</sup> ).		N/A
Annex DVH (DVH.4)	Permanently connected equipment is required to have a suitable wiring compartment and wire bending space.		N/A
Annex DVH (DVH 5.5)	Equipment connected to a centralized d.c. power system, and having one pole of the DC mains input terminal connected to the main protective earthing terminal in the equipment, complies with special earthing, wiring, marking and installation instruction requirements.		N/A
Annex DVI (6.7 )	Equipment intended for connection to telecommunication network outside plant cable is required to be protected against overvoltage from power line crosses.		N/A



IEC62368_1B ATTACHMENT			
Clause	Requirement + Test	Result - Remark	Verdict
Annex DVJ (10.6.1 )	Equipment connected to a telecommunication and cable distribution networks and supplied with an earphone intended to be held against, or in the ear is required to comply with special acoustic pressure requirements.		N/A

Product: DC-DC Converter

Type Designation: H0505S-1WR2-YG

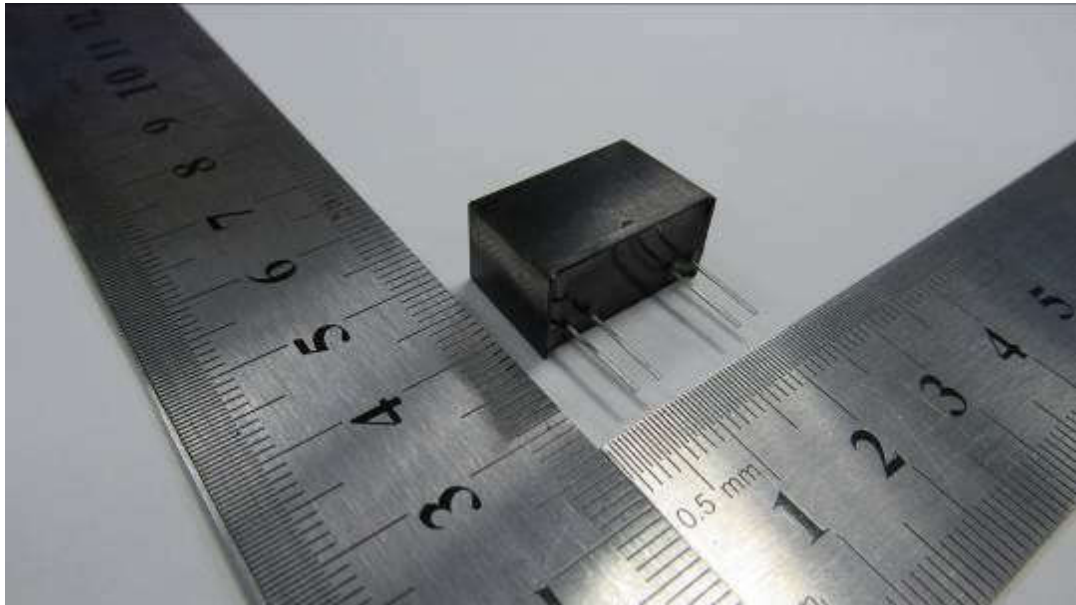

Figure 1. Overall view

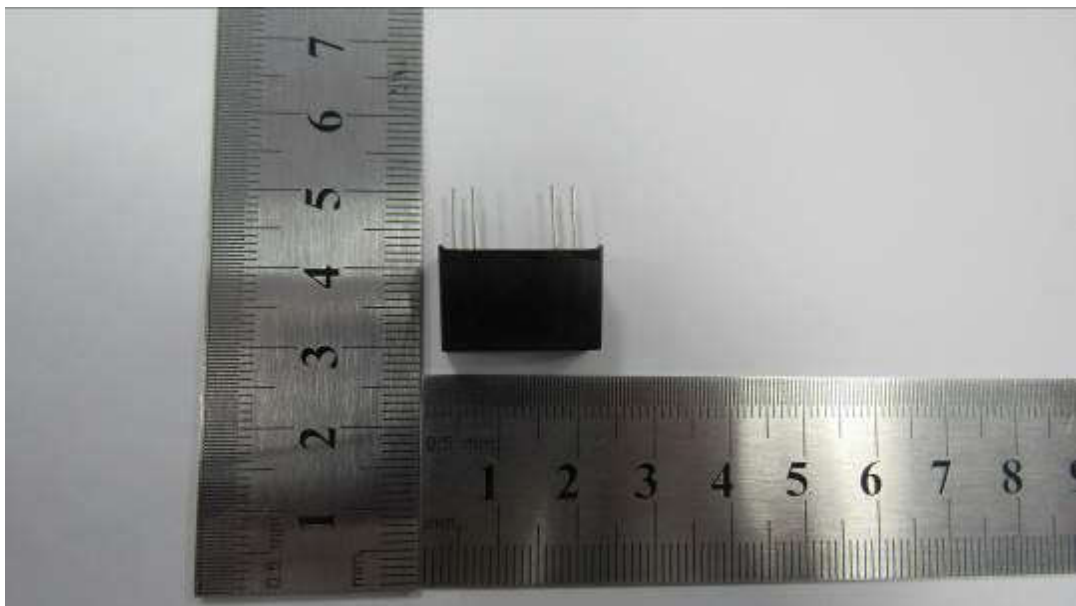

Figure 2. Overall view

Product: DC-DC Converter

Type Designation: H0505S-1WR2-YG

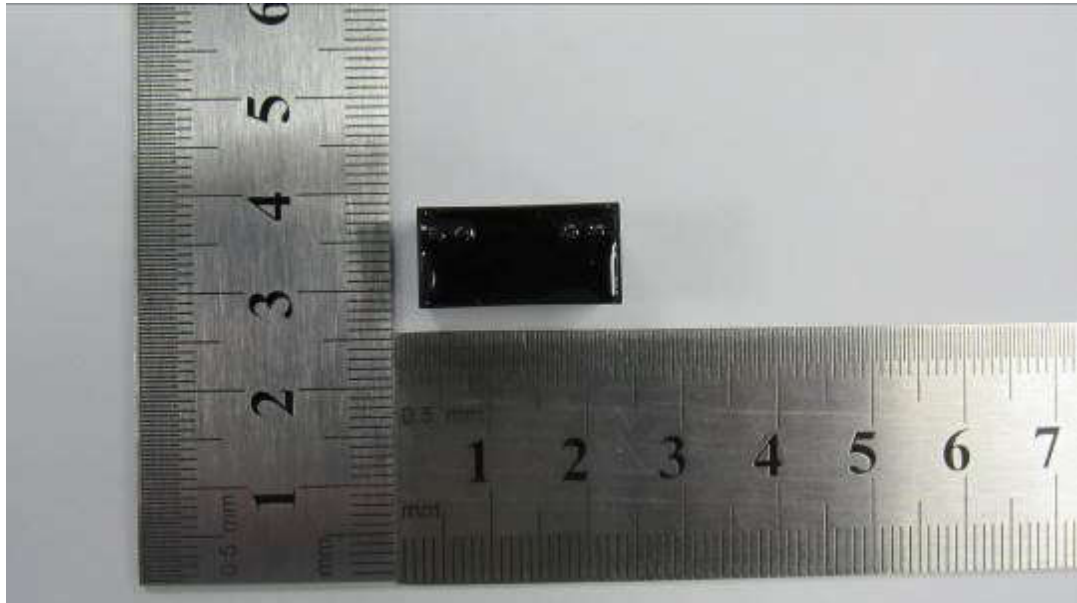

Figure 3. Overall view

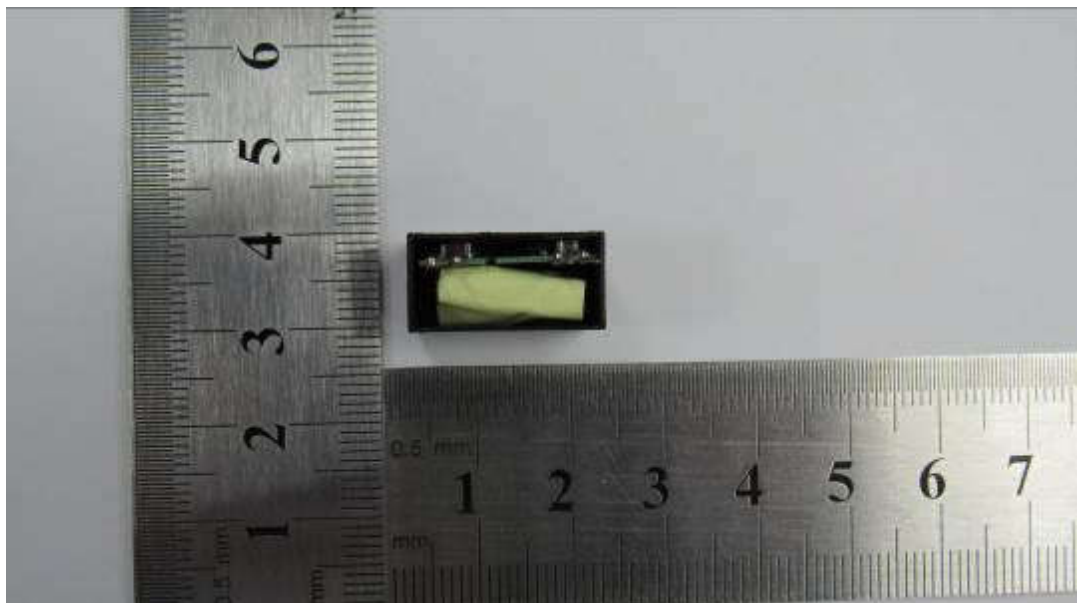

Figure 4. Internal view with enclosure opened

Product: DC-DC Converter

Type Designation: H0505S-1WR2-YG

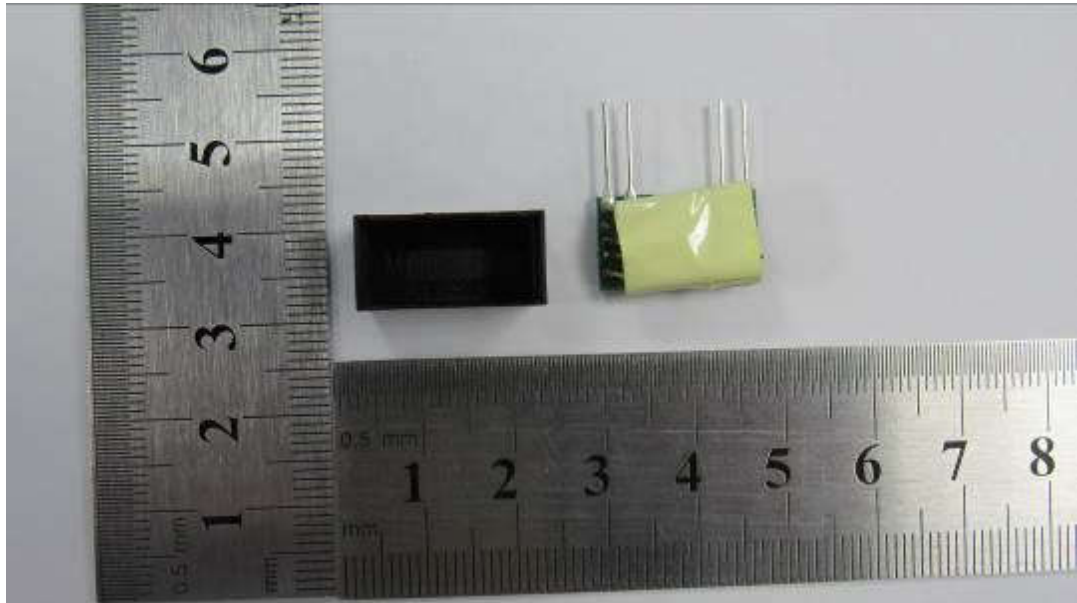

Figure 5. Internal view with enclosure opened

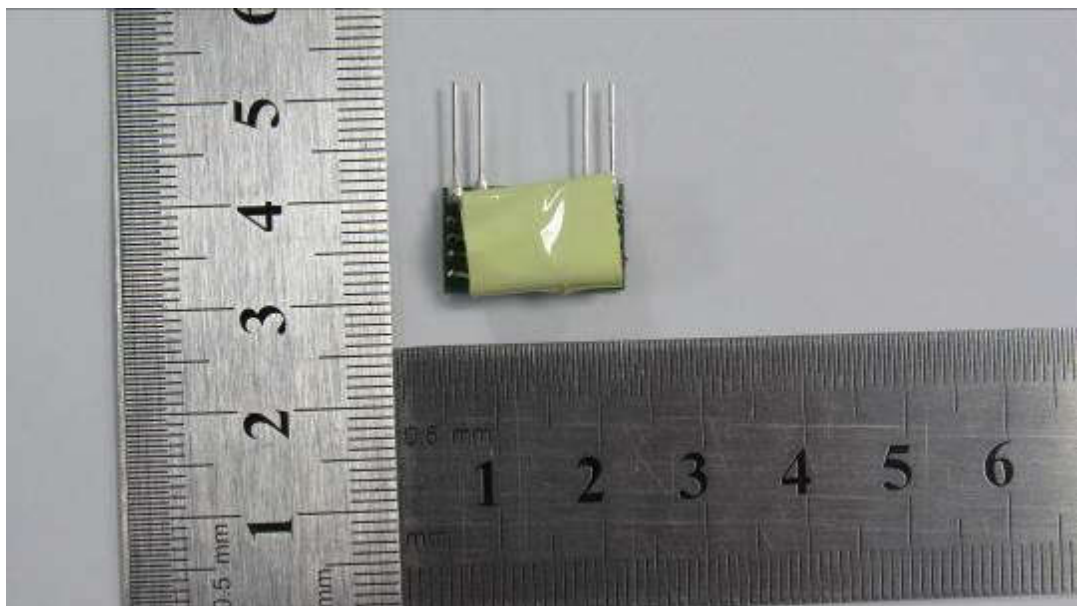

Figure 6. Internal view

Product: DC-DC Converter

Type Designation: H0505S-1WR2-YG

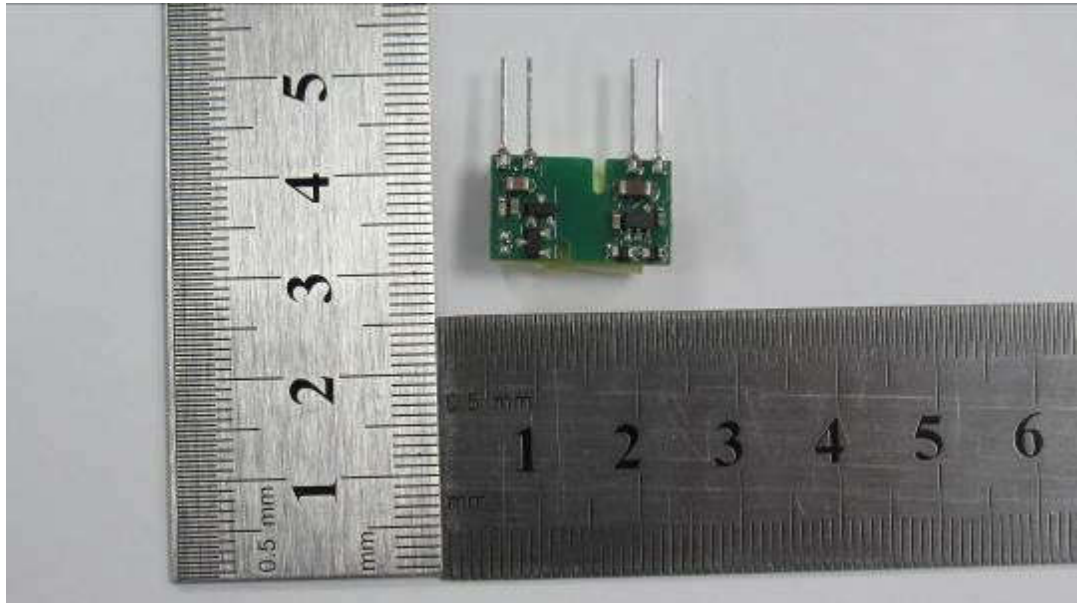

Figure 7. Internal view

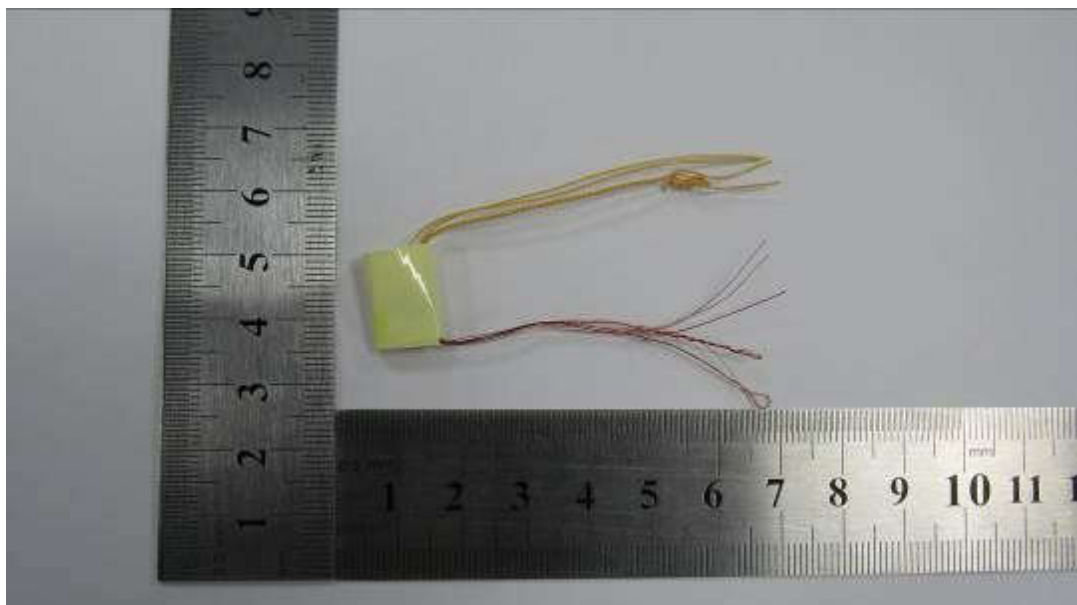

Figure 8. Overall view of transformer

Product: DC-DC Converter

Type Designation: H0505S-1WR2-YG

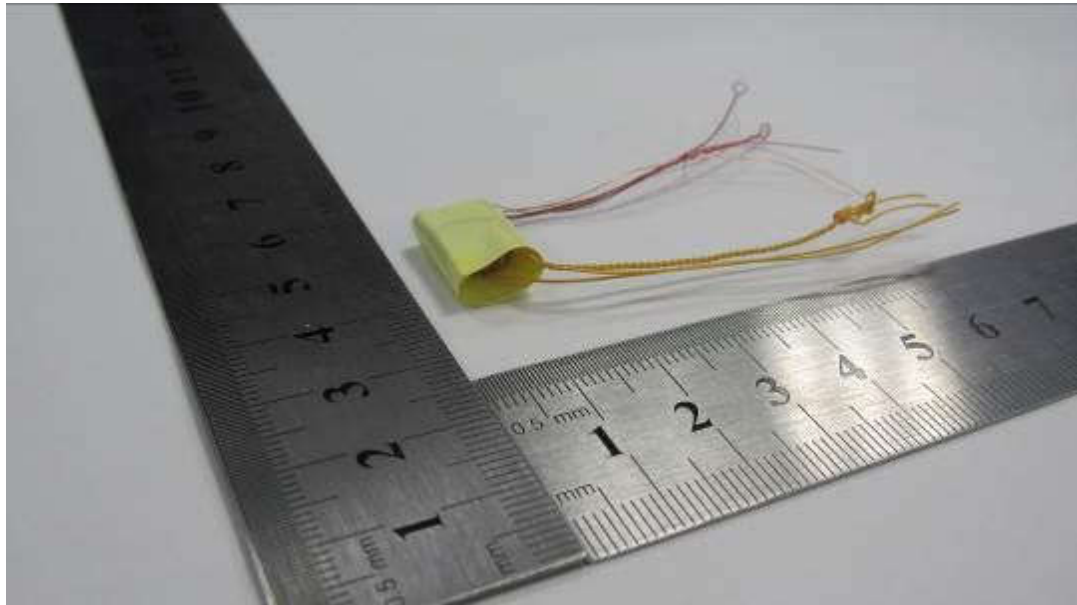

Figure 9. Overall view of transformer

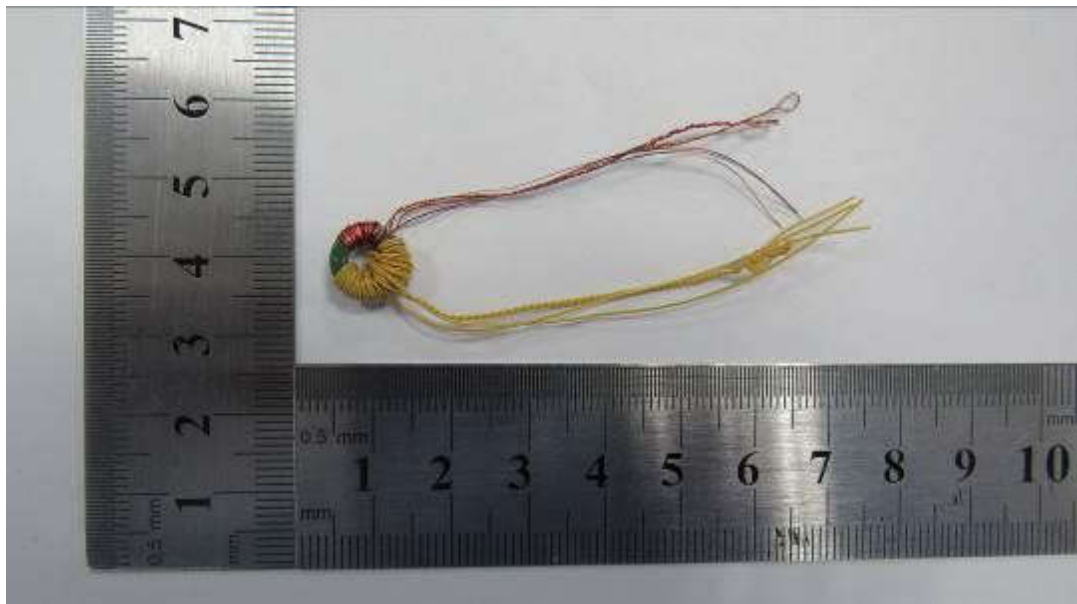

Figure 10. Internal view of transformer